

RIGOL

User's Guide

DSG3000 Series RF Signal Generator

Nov. 2013
RIGOL Technologies, Inc.

Guaranty and Declaration

Copyright

© 2013 RIGOL Technologies, Inc. All Rights Reserved.

Trademark Information

RIGOL is a registered trademark of RIGOL Technologies, Inc.

Publication Number

UGG01106-1110

Notices

- **RIGOL** products are protected by patent law in and outside of P.R.C.
- **RIGOL** reserves the right to modify or change parts of or all the specifications and pricing policies at company's sole decision.
- Information in this publication replaces all previously corresponding material.
- **RIGOL** shall not be liable for losses caused by either incidental or consequential in connection with the furnishing, use or performance of this manual as well as any information contained.
- Any part of this document is forbidden to be copied or photocopied or rearranged without prior written approval of **RIGOL**.

Product Certification

RIGOL guarantees this product conforms to the national and industrial standards in China as well as the ISO9001:2008 standard and the ISO14001:2004 standard. Other international standard conformance certification is in progress.

Contact Us

If you have any problem or requirement when using our products or this manual, please contact **RIGOL**.

E-mail: service@rigol.com

Websites: www.rigol.com

Safety Requirement

General Safety Summary

Please review the following safety precautions carefully before putting the instrument into operation so as to avoid any personal injury or damage to the instrument and any product connected to it. To prevent potential hazards, please use the instrument only specified by this manual.

Use Proper Power Cord.

Only the power cord designed for the instrument and authorized for use within the local country should be used.

Ground The Instrument.

The instrument is grounded through the Protective Earth lead of the power cord. To avoid electric shock, it is essential to connect the earth terminal of power cord to the Protective Earth terminal before connecting any inputs or outputs.

Connect the Probe Correctly.

If a probe is used, do not connect the ground lead to high voltage since it has the isobaric electric potential as ground.

Observe All Terminal Ratings.

To avoid fire or shock hazard, observe all ratings and markers on the instrument and check your manual for more information about ratings before connecting.

Use Proper Overvoltage Protection.

Make sure that no overvoltage (such as that caused by a thunderstorm) can reach the product, or else the operator might expose to danger of electrical shock.

Do Not Operate Without Covers.

Do not operate the instrument with covers or panels removed.

Do Not Insert Anything into the Holes of Fan.

Do not insert anything into the holes of the fan to avoid damaging the instrument.

Use Proper Fuse.

Please use the specified fuses.

Avoid Circuit or Wire Exposure.

Do not touch exposed junctions and components when the unit is powered.

Do Not Operate With Suspected Failures.

If you suspect damage occurs to the instrument, have it inspected by qualified

service personnel before further operations. Any maintenance, adjustment or replacement especially to circuits or accessories must be performed by **RIGOL** authorized personnel.

Keep Well Ventilation.

Inadequate ventilation may cause increasing of temperature or damages to the device. So please keep well ventilated and inspect the intake and fan regularly.

Do Not Operate in Wet Conditions.

In order to avoid short circuiting to the interior of the device or electric shock, please do not operate in a humid environment.

Do Not Operate in an Explosive Atmosphere.

In order to avoid damages to the device or personal injuries, it is important to operate the device away from an explosive atmosphere.

Keep Product Surfaces Clean and Dry.

To avoid the influence of dust and/or moisture in air, please keep the surface of the device clean and dry.

Electrostatic Prevention.

Operate in an electrostatic discharge protective area environment to avoid damages induced by static discharges. Always ground both the internal and external conductors of the cable to release static before connecting.

Proper Use of Battery.

If a battery is supplied, it must not be exposed to high temperature or in contact with fire. Keep it out of the reach of children. Improper change of battery (note: lithium battery) may cause explosion. Use **RIGOL** specified battery only.

Do Not Overload the Output.

In order to avoid damage to the instrument, the reverse DC voltage on the RF output connector cannot exceed 50 V; the reverse power must be less than +40 dBm (10 W) in the frequency range from 1 MHz to 6 GHz.

Handling Safety.

Please handle with care during transportation to avoid damage to buttons, knob interfaces and other parts on the panels.

Safety Terms and Symbols

Terms Used in this Manual. These terms may appear in this manual:



WARNING

Warning statements indicate the conditions or practices that could result in injury or loss of life.



CAUTION

Caution statements indicate the conditions or practices that could result in damage to this product or other property.

Terms Used on the Product. These terms may appear on the Product:

DANGER indicates an injury or hazard may immediately happen.

WARNING indicates an injury or hazard may be possible.

CAUTION indicates potential damage to the instrument or other.

Symbols Used on the Product. These symbols may appear on the product:



Hazardous Voltage



Safety Warning



Protective Earth Terminal



Chassis Ground



Test Ground

Allgemeine Sicherheits Informationen

Überprüfen Sie die folgenden Sicherheitshinweise sorgfältig um Personenschäden oder Schäden am Gerät und an damit verbundenen weiteren Geräten zu vermeiden. Zur Vermeidung von Gefahren, nutzen Sie bitte das Gerät nur so, wie in diesem Handbuch angegeben.

Um Feuer oder Verletzungen zu vermeiden, verwenden Sie ein ordnungsgemäßes Netzkabel.

Verwenden Sie für dieses Gerät nur das für ihr Land zugelassene und genehmigte Netzkabel.

Erden des Gerätes.

Das Gerät ist durch den Schutzleiter im Netzkabel geerdet. Um Gefahren durch elektrischen Schlag zu vermeiden, ist es unerlässlich, die Erdung durchzuführen. Erst dann dürfen weitere Ein- oder Ausgänge verbunden werden.

Anschluss eines Tastkopfes.

Die Erdungsklemmen der Sonden sind auf dem gleichen Spannungspegel des Instruments geerdet. Schließen Sie die Erdungsklemmen an keine hohe Spannung an.

Beachten Sie alle Anschlüsse.

Zur Vermeidung von Feuer oder Stromschlag, beachten Sie alle Bemerkungen und Markierungen auf dem Instrument. Befolgen Sie die Bedienungsanleitung für weitere Informationen, bevor Sie weitere Anschlüsse an das Instrument legen.

Verwenden Sie einen geeigneten Überspannungsschutz.

Stellen Sie sicher, daß keinerlei Überspannung (wie z.B. durch Gewitter verursacht) das Gerät erreichen kann. Andernfalls besteht für den Anwender die Gefahr eines Stromschlages.

Nicht ohne Abdeckung einschalten.

Betreiben Sie das Gerät nicht mit entfernten Gehäuse-Abdeckungen.

Betreiben Sie das Gerät nicht geöffnet.

Der Betrieb mit offenen oder entfernten Gehäuseteilen ist nicht zulässig. Nichts in entsprechende Öffnungen stecken (Lüfter z.B.)

Passende Sicherung verwenden.

Setzen Sie nur die spezifikationsgemäßen Sicherungen ein.

Vermeiden Sie ungeschützte Verbindungen.

Berühren Sie keine unisolierten Verbindungen oder Baugruppen, während das Gerät in Betrieb ist.

Betreiben Sie das Gerät nicht im Fehlerfall.

Wenn Sie am Gerät einen Defekt vermuten, sorgen Sie dafür, bevor Sie das Gerät wieder betreiben, dass eine Untersuchung durch qualifiziertes Kundendienstpersonal durchgeführt wird. Jedwede Wartung, Einstellarbeiten oder Austausch von Teilen am Gerät, sowie am Zubehör dürfen nur von **RIGOL** autorisiertem Personal durchgeführt werden.

Belüftung sicherstellen.

Unzureichende Belüftung kann zu Temperaturanstiegen und somit zu thermischen Schäden am Gerät führen. Stellen Sie deswegen die Belüftung sicher und kontrollieren regelmäßig Lüfter und Belüftungsöffnungen.

Nicht in feuchter Umgebung betreiben.

Zur Vermeidung von Kurzschluß im Geräteinneren und Stromschlag betreiben Sie das Gerät bitte niemals in feuchter Umgebung.

Nicht in explosiver Atmosphäre betreiben.

Zur Vermeidung von Personen- und Sachschäden ist es unumgänglich, das Gerät ausschließlich fernab jedweder explosiven Atmosphäre zu betreiben.

Geräteoberflächen sauber und trocken halten.

Um den Einfluß von Staub und Feuchtigkeit aus der Luft auszuschließen, halten Sie bitte die Geräteoberflächen sauber und trocken.

Schutz gegen elektrostatische Entladung (ESD).

Sorgen Sie für eine elektrostatisch geschützte Umgebung, um somit Schäden und Funktionsstörungen durch ESD zu vermeiden. Erden Sie vor dem Anschluß immer Innen- und Außenleiter der Verbindungsleitung, um statische Aufladung zu entladen.

Die richtige Verwendung des Akku.

Wenn eine Batterie verwendet wird, vermeiden Sie hohe Temperaturen bzw. Feuer ausgesetzt werden. Bewahren Sie es außerhalb der Reichweite von Kindern auf. Unsachgemäße Änderung der Batterie (Anmerkung: Lithium-Batterie) kann zu einer Explosion führen. Verwenden Sie nur von RIGOL angegebene Akkus.

Sicherer Transport.

Transportieren Sie das Gerät sorgfältig (Verpackung!), um Schäden an Bedienelementen, Anschlüssen und anderen Teilen zu vermeiden.

Sicherheits Begriffe und Symbole

Begriffe in diesem Guide. Diese Begriffe können in diesem Handbuch auftauchen:



WARNING

Die Kennzeichnung WARNING beschreibt Gefahrenquellen die leibliche Schäden oder den Tod von Personen zur Folge haben können.



CAUTION

Die Kennzeichnung Caution (Vorsicht) beschreibt Gefahrenquellen die Schäden am Gerät hervorrufen können.

Begriffe auf dem Produkt. Diese Bedingungen können auf dem Produkt erscheinen:

DANGER

weist auf eine Verletzung oder Gefährdung hin, die sofort geschehen kann.

WARNING

weist auf eine Verletzung oder Gefährdung hin, die möglicherweise nicht sofort geschehen.

CAUTION

bedeutet, dass eine mögliche Beschädigung des Instruments oder anderer Gegenstände auftreten kann.

Symbole auf dem Produkt. Diese Symbole können auf dem Produkt erscheinen:



Gefährliche Spannung



Sicherheits-Hinweis



Schutz-erde



Gehäusemasse



Erde

General Care and Cleaning

General Care:

Do not store or leave the instrument where it may be exposed to direct sunlight for long periods of time.

Cleaning:

Clean the instrument regularly according to its operating conditions. To clean the exterior surface, perform the following steps:

1. Disconnect the instrument from all power sources.
2. Clean the loose dust on the outside of the instrument with a lint-free cloth (with a mild detergent or water). When cleaning the LCD, take care to avoid scratching it.



CAUTION

To avoid damage to the instrument, do not expose to caustic liquids.



WARNING

To avoid injury resulting from a short circuit, make sure the instrument is completely dry before reconnecting to a power source.

Environmental Considerations

The following symbol indicates that this product complies with the applicable European Union requirements according to Directives 2002/96/EC on waste electrical and electronic equipment (WEEE) and batteries.



Product End-of-Life Handling

The equipment may contain substances that could be harmful to the environment or human health. In order to avoid release of such substances into the environment and harm to human health, we encourage you to recycle this product in an appropriate system that will ensure that most of the materials are reused or recycled appropriately. Please contact your local authorities for disposal or recycling information.

DSG3000 Series Overview

The DSG3000 series is a high-performance RF signal generator. It provides comprehensive modulation solutions such as: pulse modulation with customizable pulse train and I/Q modulation (optional), and standard AM/FM/ ϕ M analog modulation. All modulation schemes support internal and external modulation sources. In addition, to meet the demands of production environments, the DSG3000 is designed to be both highly stable and reliable. The DSG3000 series also features a clear user interface, small size and light weight. It is easy to operate and can output stable, precise and pure signals. It is an ideal tool for various fields such as communication, computers, instrumentation, R&D, education, production and maintenance.

Main Features:

- The highest frequency: 3 GHz/6 GHz
- Amplitude accuracy: <0.5dB (typical)
- Output amplitude range: -130 dBm to +13 dBm
- High signal purity, phase noise: <-110dBc/Hz@20kHz (typical)
- Standard 0.5ppm internal clock; 5ppb high stable clock for option
- Standard AM/FM/ ϕ M analog modulation
- Standard pulse modulation; on/off ratio up to 80dB; pulse train generator (optional)
- I/Q modulation and I/Q baseband output
- All modulation schemes support internal and external modulation modes
- Standard 2U height design to save rack space. Rack mount kit is available
- Standard USB/LAN/GPIB remote control interfaces. SCPI command set for remote control
- Wear-free electronic attenuator design
- Well-designed automatic flatness calibration function (Cables, attenuators, amplifiers and so on) for test systems with power meter control

Document Overview

Main contents in this manual

Chapter 1 Quick Start

This chapter introduces the front panel, rear panel and user interface of the RF signal generator as well as the precautions when using the instrument for the first time.

Chapter 2 Front Panel Operations

This chapter describes the front panel function keys of the RF signal generator and introduces the menu functions under each key in details.

Chapter 3 Remote Control

This chapter introduces the remote control method of RF signal generator.

Chapter 4 Application Examples

This chapter describes intuitively RF signal generator with operation examples.

Chapter 5 Troubleshooting

This chapter lists commonly encountered failures that may appear during the use of the RF signal generator and their solutions.

Chapter 6 Specifications

This chapter lists the performances and general specifications of the instrument.

Chapter 7 Appendix

This chapter provides the information about the options and accessories, as well as other points for attention.

Format Conventions in this Manual

1. Button:

The key at the front panel is denoted by the following format: "Text Box + Button Name (Bold)" in the manual, for example, **FREQ** denotes the **FREQ** key.

2. Menu:

The menu is denoted by the following format: "Character Shading + Menu Word (Bold)" in the manual, for example, **Frequency** denotes the frequency item under **FREQ**.

3. Connector:

The connector at the front or rear panel is denoted by the following format: "Square Brackets + Connector Name (Bold)" in the manual, for example, **[RF OUTPUT 50Ω]**.

4. Operation Steps:

The next step of the operation is denoted by an arrow "→" in the manual. For example, **FREQ** → **Frequency** denotes pressing **FREQ** on the front panel and then pressing **Frequency**.

Content Conventions in this Manual

The DSG3000 series RF signal generator includes the modes DSG3030 and DSG3060. The illustrations in this manual are based on DSG3060.

Model	Frequency Range
DSG3030	9kHz ~ 3GHz
DSG3060	9kHz ~ 6GHz

Manuals of this Product

The manuals of this product include the quick guide, user's guide, programming guide and data sheet. The latest versions of the manuals can be downloaded from www.rigol.com.

Contents

Guaranty and Declaration	I
Safety Requirement	II
General Safety Summary.....	II
Safety Terms and Symbols	IV
Allgemeine Sicherheits Informationen	V
Sicherheits Begriffe und Symbole.....	VII
General Care and Cleaning.....	VIII
Environmental Considerations.....	VIII
DSG3000 Series Overview	IX
Document Overview	X
Chapter 1 Quick Start	1-1
General Inspection	1-2
Appearance and Dimensions	1-3
Front Panel Overview	1-5
Rear Panel Overview	1-12
To Use DSG3000 for the First Time	1-17
To Connect the Power Supply.....	1-17
Power-on Inspection	1-18
To Set the System Language.....	1-18
To Replace the Fuse	1-19
User Interface.....	1-20
Normal Display Mode	1-20
Parameter Zoom-in Mode	1-23
To Use the Built-in Help System.....	1-24
Chapter 2 Front Panel Operations	2-1
To Set the Frequency Parameters.....	2-2
Frequency.....	2-2
Frequency Offset	2-2
Phase Offset	2-3
To Set the Amplitude Parameters	2-4
Amplitude	2-4
Amplitude Limit	2-4
Amplitude Offset.....	2-5
Attenuation Mode	2-6
Attenuation	2-6
ALC	2-7
Hold Mode	2-7
Flatness Calibration.....	2-7
Amplitude Unit	2-9
Sweep.....	2-10

Sweep Manner.....	2-10
Sweep Direction.....	2-10
Sweep Type.....	2-11
Sweep Mode.....	2-15
Single Sweep.....	2-16
Reset Sweep	2-16
Trigger Mode.....	2-16
Modulation	2-19
Amplitude Modulation (AM).....	2-19
Frequency Modulation (FM).....	2-22
Phase Modulation (ϕ M).....	2-24
Pulse Modulation	2-26
I/Q Modulation (Option IQ-DSG3000)	2-34
LF Output.....	2-39
To Enable the LF Output	2-39
To Set the LF Parameters.....	2-39
Power Meter (Option PMC-DSG3000).....	2-44
To Enable the Power Meter	2-44
Zero Type.....	2-45
Zero	2-45
Frequency Mode	2-45
Frequency.....	2-45
Average Measurement.....	2-46
Preset.....	2-46
Limit Measurement	2-46
Recorder	2-48
Relative Measurement	2-49
Statistics	2-49
Unit.....	2-50
System Information.....	2-50
RX1000 (Option)	2-51
Store and Recall.....	2-52
File Type	2-52
Save.....	2-54
Recall	2-57
Rename	2-57
Delete.....	2-58
Copy.....	2-58
To Create a Directory	2-58
Filename Prefix.....	2-59
Disk Management	2-59
System Update	2-59
To Set the System Parameters	2-60
Language.....	2-60
Reset.....	2-60
I/O Configuration.....	2-61

Display Setting	2-63
Power Status.....	2-63
Information.....	2-63
License.....	2-64
Self-test.....	2-65
Sanitation	2-65
Chapter 3 Remote Control	3-1
Remote Control Overview	3-2
Control Via USB	3-3
Control Via LAN.....	3-5
Control Via GPIB	3-8
Chapter 4 Application Examples	4-1
To Output RF Signal	4-2
To Output RF Sweep Signal	4-3
To Output RF Modulated Signal	4-5
Pulse Train Application.....	4-6
Chapter 5 Troubleshooting	5-1
Chapter 6 Specifications	6-1
Specifications	6-2
Frequency.....	6-2
Level	6-4
Internal Modulation Generator (LF)	6-5
Modulation ^[1]	6-6
Inputs and Outputs.....	6-10
General Specifications	6-11
Chapter 7 Appendix	7-1
Appendix A: DSG3000 Accessories and options	7-1
Appendix B: Warranty.....	7-2
Index.....	1

Chapter 1 Quick Start

This chapter guides users to quickly get familiar with the appearance, dimensions, front panel, rear panel, and the user interface of DSG3000 series RF signal generator.

The contents of this chapter are as follows:

- General Inspection
- Appearance and Dimensions
- Front Panel Overview
- Rear Panel Overview
- To Use DSG3000 for the First Time
- To Replace the Fuse
- User Interface
- To Use the Built-in Help System

General Inspection

1. Inspect the shipping container for damage

Keep the damaged shipping container or cushioning material until the contents of the shipment have been checked for completeness and the instrument has passed both electrical and mechanical tests.

The consigner or carrier shall be liable for the damage to instrument resulting from shipment. **RIGOL** is not responsible for free maintenance/rework or replacement of the unit in such cases.

2. Inspect the instrument

In case of any damage, or defect, or failure, notify your **RIGOL** sales representative immediately.

3. Check the accessories

Please check the accessories according to the packing lists. If the accessories are incomplete or damaged, please contact your **RIGOL** sales representative immediately.

Appearance and Dimensions

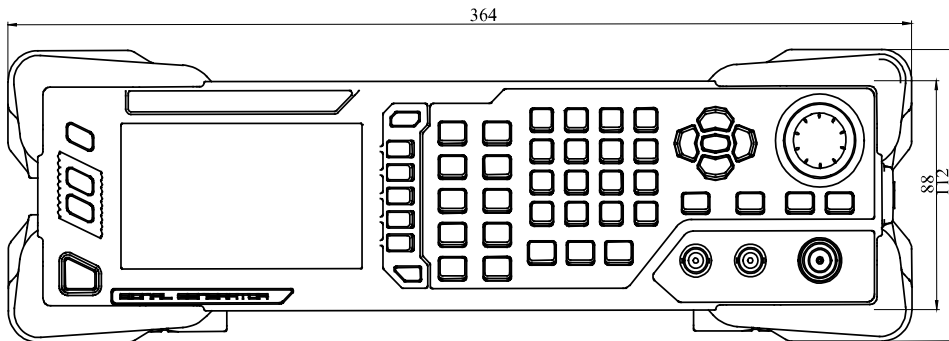

Figure 1-1 Front View (unit: mm)

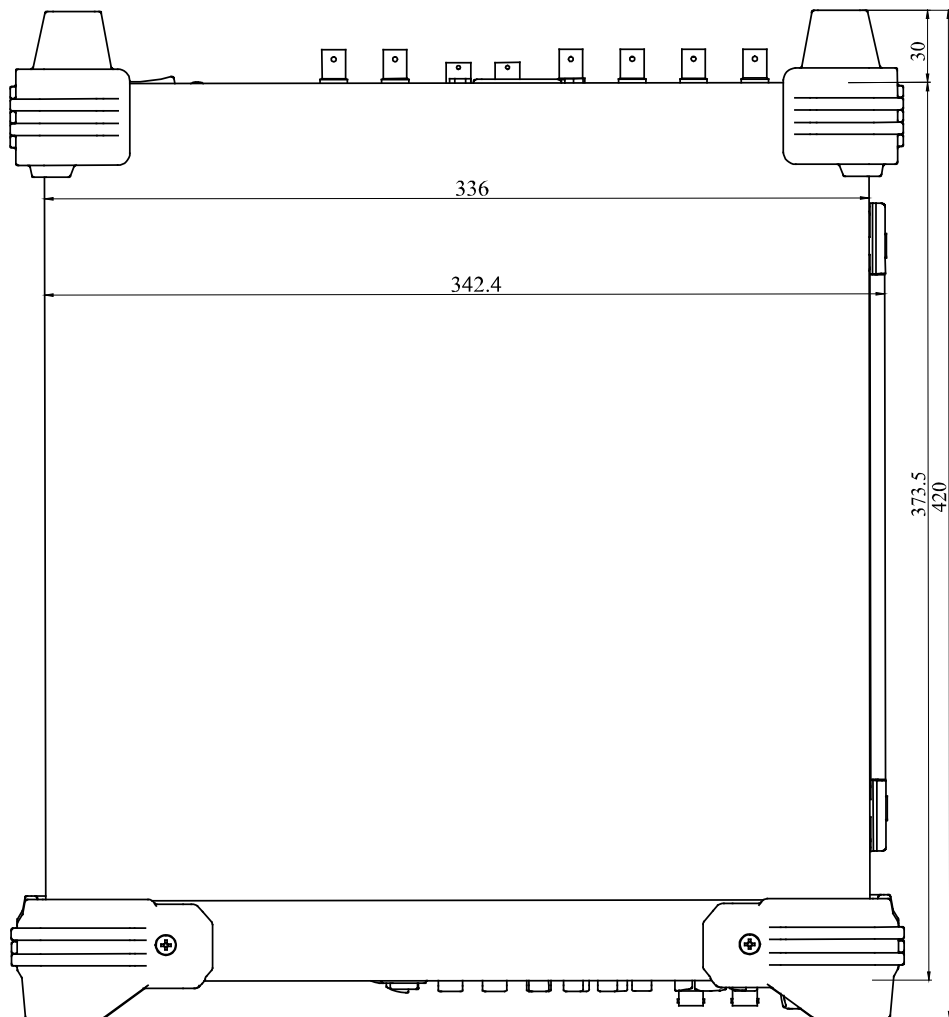

Figure 1-2 Top View (unit: mm)

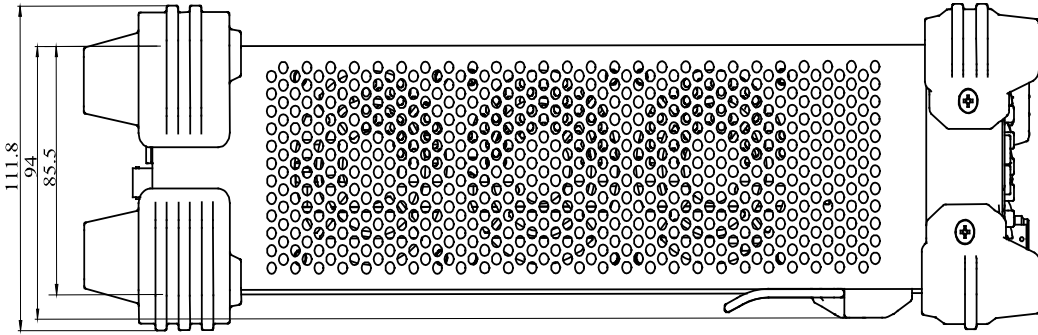

Figure 1-3 Lateral View (unit: mm)

Front Panel Overview

The front panel of DSG3000 series RF signal generator is as shown in the figure below. Click the number in the figure to view the corresponding introduction.

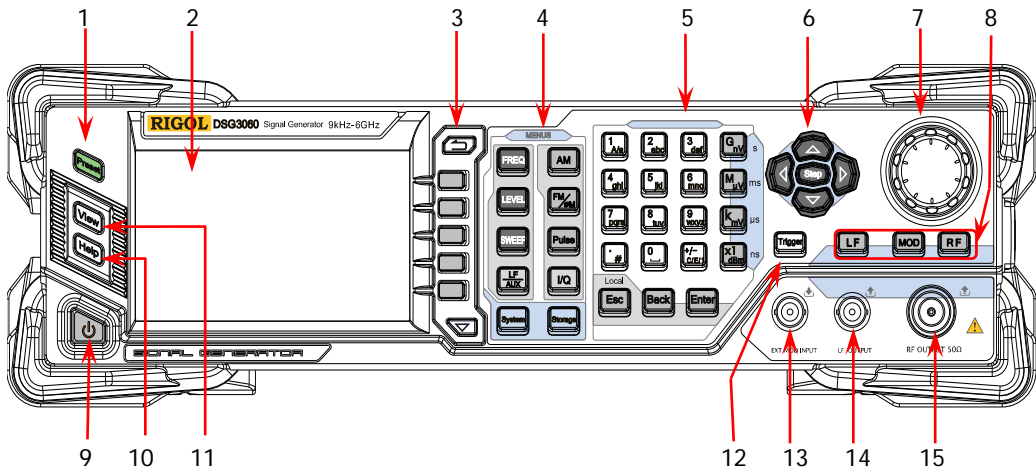

Figure 1-4 Front Panel

1. Restore to Preset Key



Restore the instrument to the preset state (factory state or user-stored state).

2. LCD Display

4.3 inch TFT high-resolution (480×272) color LCD display. The current settings and state of the instrument can be clearly displayed. For detailed information, refer to **"User Interface"**.

3. Menu Control Keys



Quit the current menu and return to the previous menu.

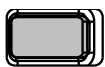

Menu softkey. Corresponds to the menu label at the left of the softkey on the display. Press the softkey to activate the corresponding menu.



Menu page up/down key.

4. Function Keys



Set the frequency, frequency offset and phase offset of the RF output signal. For details, refer to **"To Set the Frequency Parameters"**.



Set the amplitude and attenuation of the RF output signal and provide the flatness calibration function. For details, refer to **"To Set the Amplitude Parameters"**.



Set the sweep type, sweep manner and sweep mode. For details, refer to **"Sweep"**.



Set the parameters relating to amplitude modulation (AM). For details, refer to **"Amplitude Modulation (AM)"**.



Set the parameters relating to frequency modulation (FM) and phase modulation (Φ M). For details, refer to **"Frequency Modulation (FM)"** and **"Phase Modulation (Φ M)"**.



Set the parameters relating to pulse modulation and pulse generator. For details, refer to **"Pulse Modulation"**.



Set the parameters relating to I/Q modulation and I/Q modulation source.



Set the parameters relating to LF output and other extended functions.



Store and recall the instrument state, flatness calibration data, sweep list and so on. For details, refer to **"Store and Recall"**.



Set the system-related parameters. For details, refer to **"To Set the System Parameters"**.

5. Numeric Keyboard

The numeric keyboard supports Chinese characters, English uppercase /lowercase characters, numbers and commonly used symbols (include the decimal point, #, space and positive/negative sign+/-). It is mainly used to edit the file or folder name or set parameters.

The multiplexing key of number and letter is used to directly input the desired number or letter.



Used to switch among Chinese, English and number input modes.

When setting parameters, the input mode is fixed at number and this key is used to input the sign (“+” or “-”) of the value.



In number input mode, press this key to input 1.

In English input mode, press this key to switch between uppercase and lowercase letter input.



The multiplexing key of 0 and space:

In number input mode, press this key to input 0.

In Chinese or English input mode, press this key to input a space.



In number input mode, press this key to insert a decimal point at the current cursor.

In English input mode, press this key to input “#”.

In Chinese input mode, this key is invalid.

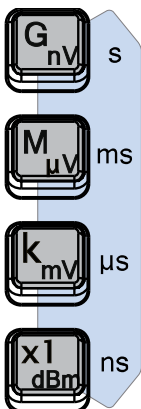

Used to set the unit of the parameter.

When setting a parameter, after using the numeric keyboard to input the numbers, press one of these keys to select the corresponding unit. The unit selected is related to the type of the parameter to be set.

Parameter	G _{nV}	M _{μV}	K _{mV}	X1 _{dBm}
Frequency	GHz	MHz	kHz	Hz
Amplitude	nV	μV	mV	dBm
Period	s	ms	μs	ns

Local



When setting parameters, use this key to clear the number in the editing window and exit the parameter input state.

When editing filenames, use this key to clear the characters in the input bar.

During the keyboard test, use this key to exit the current test state.

When the instrument is in remote mode, use this key to return to local mode.



When setting parameters, use this key to delete the number at the left of the cursor.

When editing filenames, use this key to delete the character at the left of the cursor.

For the storage function, it is used to collapse the directory currently selected.



When setting parameters, use this key to finish the parameter input and add the default unit for the parameter.

When editing filenames, use this key to input the character currently selected by the cursor.

For the storage function, it is used to expand the directory currently selected.

6. Direction Keys/Step Key

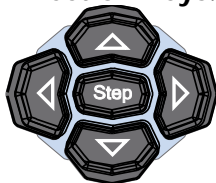

When setting the parameters, **Step** is used to set the step of the parameter currently selected.

The left/right direction keys are used to enter the parameter editing state and move the cursor to the specified digit.

The up/down direction keys are used to modify the value at the cursor or modify the parameter value at the current step.

For the storage function, the left/right direction keys are used to collapse or expand the directory currently selected.

The up/down direction keys are used to select the current directory or file.

When editing filenames, they are used to select the desired character.

7. Knob

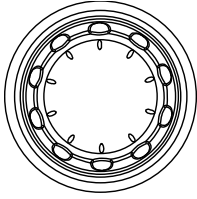

When setting parameters, the knob is used to modify the value at the cursor or modify the parameter value at the current step.

When editing filenames, it is used to select the desired character.

For the storage function, it is used to select the current directory or file.

8. Output Control Keys



Used to turn on or off the LF output.

- Press this key, the backlight goes on and the LF label is displayed in the status bar in the user interface. The LF output is turned on. At this point, the **[LF OUTPUT]** connector outputs the LF signal according to the current configuration.
- Press this key again, the backlight goes out and the LF output is turned off.



Used to turn on or off the RF output.

- Press this key, the backlight goes on and the RF label is displayed in the status bar in the user interface. The RF output is turned on. At this point, the **[RF OUTPUT 50Ω]** connector outputs RF signal or RF sweep signal according to the current configuration.
- Press this key again, the backlight goes out and the RF output is turned off.



Used to turn on or off the RF modulation output.

- Press this key, the backlight goes on and the MOD label is displayed in the status bar in the user interface. The RF modulation output is turned on. At this point, the **[RF OUTPUT 50Ω]** connector outputs modulated RF signal according to the current configuration (the backlight of **[RF]** must go on).
- Press this key again, the backlight goes out and the RF modulation output is turned off.

9. Power Key

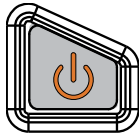

Turn on or off the signal generator. When this key is turned off, the signal generator is in standby state, indicated by a pulsing LED. To fully remove power from the instrument, flip the rear panel power switch off and remove the power cord. In addition, this key has a delayed switching function. The instrument can be turned on or off only when pressing this key and holding it down for a certain time. With this feature, you can avoid turning off the instrument because of accidentally touching the key.

Press **System** → **Power Status** to select “Open” or “Default”. When “Default” is selected, after the instrument is powered on and the power switch at the rear panel is turned on, you need to press this key to start the instrument. When “Open” is selected, the instrument will start automatically after it is powered on and the power switch at the rear panel is turned on.

10. Built-in Help System



To get the help information of any front panel key or menu softkey, press this key and then press the desired key.

11. View Switch Key



It is used to switch the interface display mode to normal mode or parameter zoom-in mode. For details, please refer to “**User Interface**”.

12. Trigger Control Key



When the trigger type of **SWEEP** is “Key”, press this key once to trigger a sweep.
When the trigger mode of **Pulse** is “Key”, press this key once to enable a pulse modulation.

13. External Modulation Input Connector

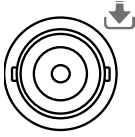

EXT MOD INPUT

When the modulation source of AM, FM and ϕ M is external, this connector is used to input the external modulating signal.

14. LF Output Connector

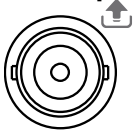

LF OUTPUT

When the backlight of **LF** goes on, this connector is used to output LF signal.

15. RF Output Connector

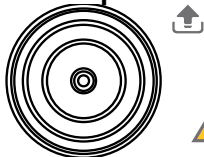
RF OUTPUT 50 Ω

When the backlight of **RF** goes on, this connector is used to output RF signal and RF sweep signal.

When the backlights of **RF** and **MOD** go on, this connector is used to output RF modulated signal.



CAUTION

To avoid damage to the instrument, the reverse DC voltage on the RF output connector cannot exceed 50 V, the reverse power must be less than +40 dBm (10W) in frequency range from 1 MHz to 6 GHz.

Rear Panel Overview

The rear panel of DSG3000 series RF signal generator is as shown in the figure below. Click the number in the figure to view the corresponding introduction.

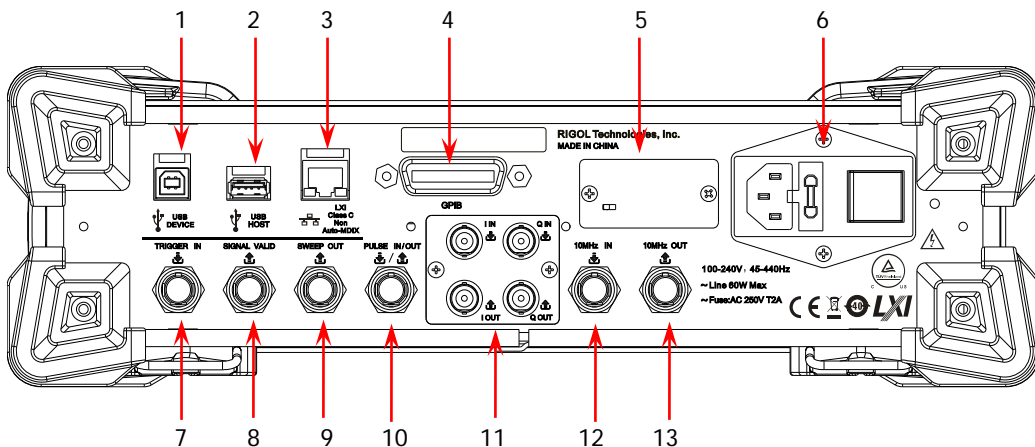

Figure 1-5 Rear Panel

1. USB Device



The instrument complies with USBTMC class protocol. This interface is used to connect to a PC for remote instrument control.

2. USB Host



This input is used to connect the USB storage device to update the system, store system states and sweep lists. You can also connect the USB power sensor or power meter with USB interface to achieve power measurement control and amplitude calibration of a measurement system.

3. LAN

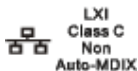
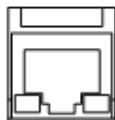

The instrument complies with LXI core device 2011 class standard, and supports WebServer, Socket and other remote control modes. This interface is used to connect the PC or network for remote instrument control.

4. GPIB

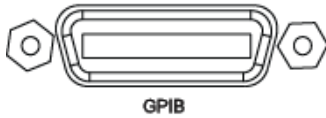

The instrument complies with the IEEE488.2 standard.

This interface is used to connect the PC to enable remote instrument control.

5. OCXO (option OCXO-A08)

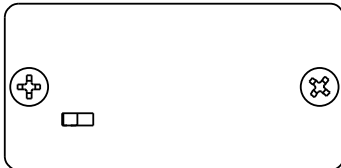

OCXO is an oven controlled crystal oscillator. It is a frequency reference source with higher temperature stability.

NOTE: Forty minutes of warm-up is required for the OCXO to reach its rated frequency.

For ordering information of this option, please refer to the *data sheet*.

6. Power Input Connector, Fuse and Switch



Power input connector.

The AC power supply specification of this signal generator is 100-240 V, 45-440 Hz. The power consumption of the instrument cannot exceed 60 W. When the signal generator is connected to AC power supply via this connector, the instrument selects the correct voltage range automatically and users do not need to select the voltage range manually.

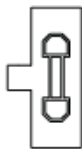

Fuse.

The fuse specification of this signal generator is AC 250 V, T2A.

If the fuse needs to be replaced, please refer to "**To Replace the Fuse**".



Power Switch

It is used to turn on or off the signal generator.

7. External Trigger Input Connector

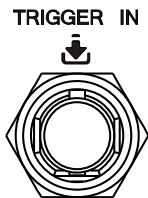

When the trigger type of **[SWEEP]** or "Swp-Sine" of LF output is "Ext", this connector is used to input the external trigger signal. You can set the polarity of trigger signal by pressing **Trig Slope** to select "Pos" or "Neg"

8. Signal Valid Output Connector

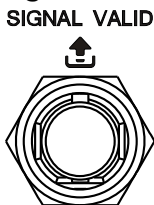

When the RF output frequency or amplitude is modified, after a certain response and processing time, the internal circuit of the instrument outputs RF signal with specified frequency and amplitude via the RF output connector at the front panel. During this process, the **[SIGNAL VALID]** connector outputs a pulse sync signal, indicating that the RF output signal is valid.

- High Level (+3.3 V): indicates that the RF signal is in configuration;
- Low Level (0 V): indicates that the RF signal is stable (namely, the signal is valid).

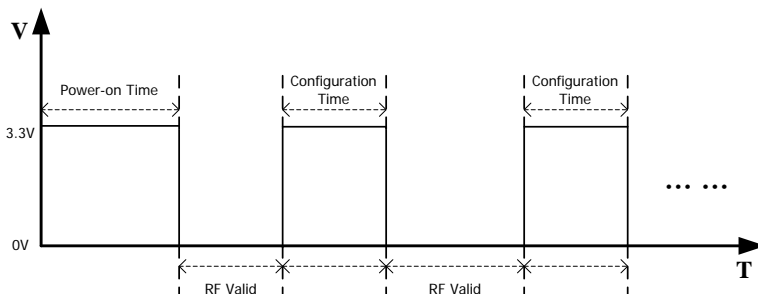

9. Sweep Output Connector

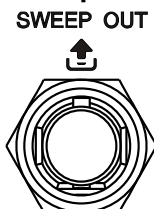

When the RF sweep function is enabled, the **[SWEEP OUT]** connector outputs a signal (0 V to +10 V) while the RF output connector at the front panel outputs the sweep signal according to the current setting. Each sweep corresponds to an output cycle.

- When the sweep type is step, this output signal is related to the choice of sweep shape which can be set to "Triangle" or "Ramp".
- When the sweep type is list, the default of this output signal is ramp.

10. Pulse Signal Input/Output Connector

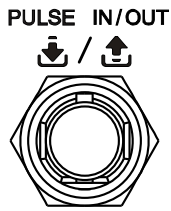

The function of this connector is determined by the current working mode of the pulse modulation.

PULSE IN:

- When the modulation source of **Pulse** is external, this connector is used to input the external pulse signal.
- When the modulation source of **Pulse** is internal and the trigger mode is "Ext Trig", this connector is used to input the external trigger signal.
- When the modulation source of **Pulse** is internal and the trigger mode is "Ext Gate", this connector is used to input the external gated signal.

PULSE OUT:

When the modulation source of **Pulse** is internal and the switch of pulse output is "on", this connector is used to output the pulse signal of the internal generator. This output signal is related to the choice of pulse mode which can be set to "Single", "Double" or "Train".

11. I/Q Modulating Signal In/Out Connectors (option IQ-DSG3000)

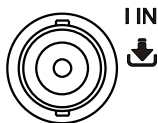

When I/Q modulation type is "external", it is used to input the I (In-Phase) baseband signal of I/Q modulation.

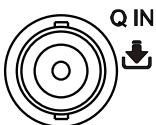

When I/Q modulation type is "external", it is used to input the Q (Quadrature Phase) modulating signal of I/Q modulation.

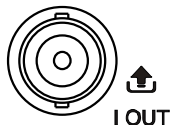

It is used to output the I (In-Phase) components of the I/Q modulation of the built-in baseband generator.



It is used to output the Q (Quadrature Phase) components of the I/Q modulation of the built-in baseband generator.

12. Reference Signal Input Connector

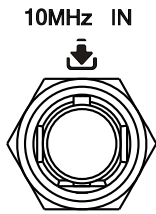

It is used to input the external 10 MHz reference clock signal which is used to synchronize the generator with other instruments. For more information about the external clock signal specification of this connector, please refer to the *data sheet*.

13. Reference Signal Output Connector

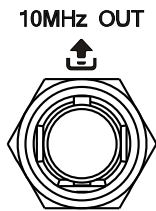

It is used to output the internal 10 MHz reference clock signal used to synchronize the generator with other instruments. For more information about the output clock signal specification of this connector, please refer to the *data sheet*.

To Use DSG3000 for the First Time

To Connect the Power Supply

Please connect the signal generator to AC power supply using the power cord supplied in the accessories as shown in the figure below. The AC power supplies specification of this signal generator is 100-240 V, 45-440 Hz. The power consumption of the instrument cannot exceed 60 W. When the signal generator is connected to AC power supply via this connector, the instrument select the correct voltage range automatically and users do not need to select the voltage range manually.

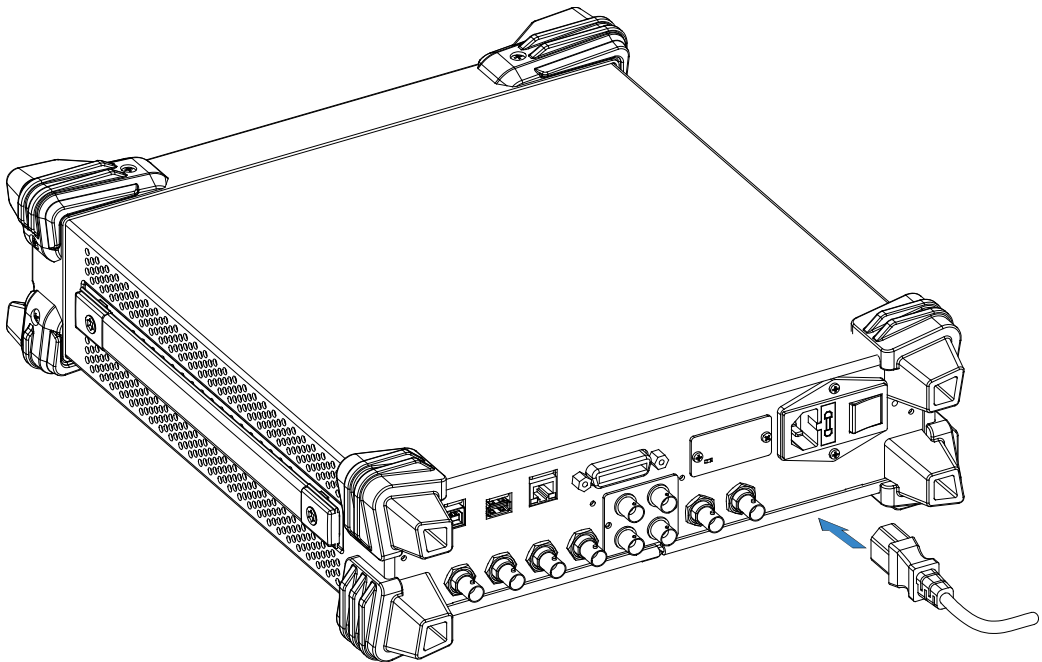



Figure 1-6 To Connect the Power Supply



CAUTION

To avoid electric shock, make sure that the instrument is correctly grounded.

Power-on Inspection

After the power supply is correctly connected, press the power switch at the rear panel and the power key  at the front panel to turn on the signal generator. During the start-up, the instrument performs initialization and self-test. After that, the instrument enters the default interface.

To Set the System Language

DSG3000 series RF signal generator supports multiple system languages. You can press **System** → **Language** to switch the system language.

To Replace the Fuse

To replace the fuse, please use the specified fuse and follow the steps below.

1. Turn off the instrument, switch off the power supply and remove the power cord
2. Use a small straight screwdriver to pry out the fuse seat
3. Take out the fuse seat
4. Replace the old fuse with a specified fuse
5. Re-install the fuse seat

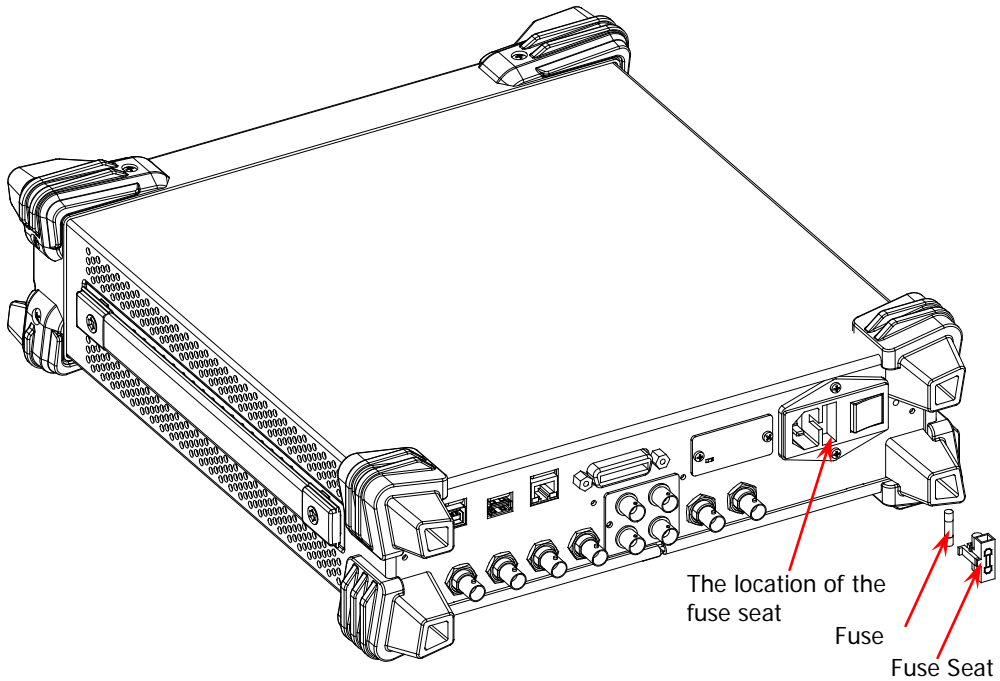

Figure 1-7 To Replace the Fuse



WARNING

To avoid electric shock, make sure that the instrument is turned off, the power supply is disconnected and the fuse used is up to standard before replacing the fuse.

User Interface

The user interface of DSG3000 series RF signal generator provides two display modes: normal display mode and parameter zoom-in mode. At power-on, the instrument enters the normal display mode by default. In this manual, the normal display mode of DSG3060 is taken as an example to illustrate the user interface of the instrument.

Normal Display Mode

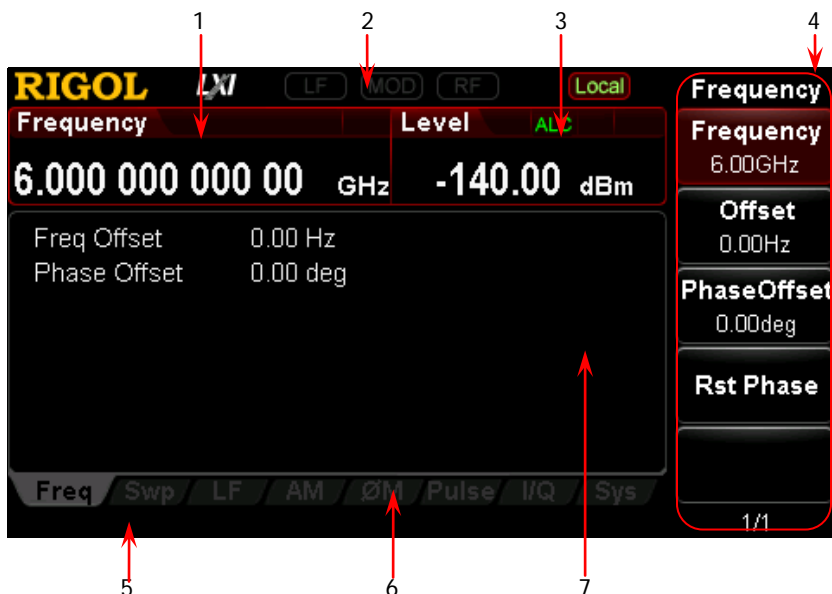

Figure 1-8 User Interface (Normal Display Mode)





1. Frequency Area

Display the current frequency setting of the RF signal generator.

- **Offs** : Displayed when the frequency offset is not 0 Hz.
- **↻** : Continuous sweep label. Displayed when the sweep type is “Freq” or “Freq&Lev” and the sweep mode is “Cont”.
- **→** : Single sweep label. Displayed when the sweep type is “Freq” or “Freq&Lev” and the sweep mode is “Single”.
- **↑** : Forward sweep label. Displayed when the sweep type is “Freq” or “Freq&Lev” and the sweep direction is “Fwd”.
- **↓** : Down sweep label. Displayed when the sweep type is “Freq” or “Freq&Lev” and the sweep direction is “Down”.
- **▬** : Frequency sweep progress bar. Displayed when the sweep type is “Freq” or “Freq&Lev”.









2. Status Bar

Indicate the states of some of the RF signal generator functions.

-  : Displayed when the LF output is enabled. This is grayed out when the LF output is disabled.
-  : Displayed when the RF modulation output is enabled. This is grayed out when the RF modulation output is disabled.
-  : Displayed when the RF output is enabled. This is grayed out when the RF output is disabled.
-  : The RF signal generator is operating in remote control mode.
-  : The RF signal generator is operating in local mode.

3. Amplitude Area

Display the current level setting of the RF signal generator.

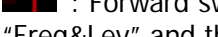
-  : Displayed when the attenuation mode is "Fixed".
-  : Displayed when the ALC state is "On".
-  : Displayed when the ALC state is "Auto".
-  : Displayed when the flatness calibration switch is "On".
-  : Displayed when the amplitude offset is not 0 dB.
-  : Continuous sweep label. Displayed when the sweep type is "Level" or "Freq&Lev" and the sweep mode is "Cont".
-  : Single sweep label. Displayed when the sweep type is "Level" or "Freq&Lev" and the sweep mode is "Single".
-  : Forward sweep label. Displayed when the sweep type is "Level" or "Freq&Lev" and the sweep direction is "Fwd".
-  : Down sweep label. Displayed when the sweep type is "Level" or "Freq&Lev" and the sweep direction is "Down".
-  : Amplitude sweep progress bar. Displayed when the sweep type is "Level" or "Freq&Lev".

4. Menu Display Area

The menus in this area correspond to the softkeys at the right of the screen. Pressing any softkey can enable the corresponding menu function.

5. Message Display Area

Display the operation error messages and prompt messages. You can press **System** → **Information** → **System Msg** to view the messages. When multiple messages are generated, you can use the up/down direction keys or knob to select the message row to be viewed. When the messages cannot be displayed completely in the list, press **Verbose** to view the complete information of the current row selected in the message list.

6. Function Status Area

Display the current active states of each function. Each function corresponds to at most four kinds of states as shown in the table below.

Type	Explanation	Example
Gray text on a black background	The function is not selected and enabled.	AM
Black text on a gray background	The function is selected and you can set the corresponding parameters.	AM
White text on a gray background	The function is selected and enabled.	AM
White text on a black background	The function is not selected but it is enabled.	AM

The status labels in the function status area as shown in the figure below.

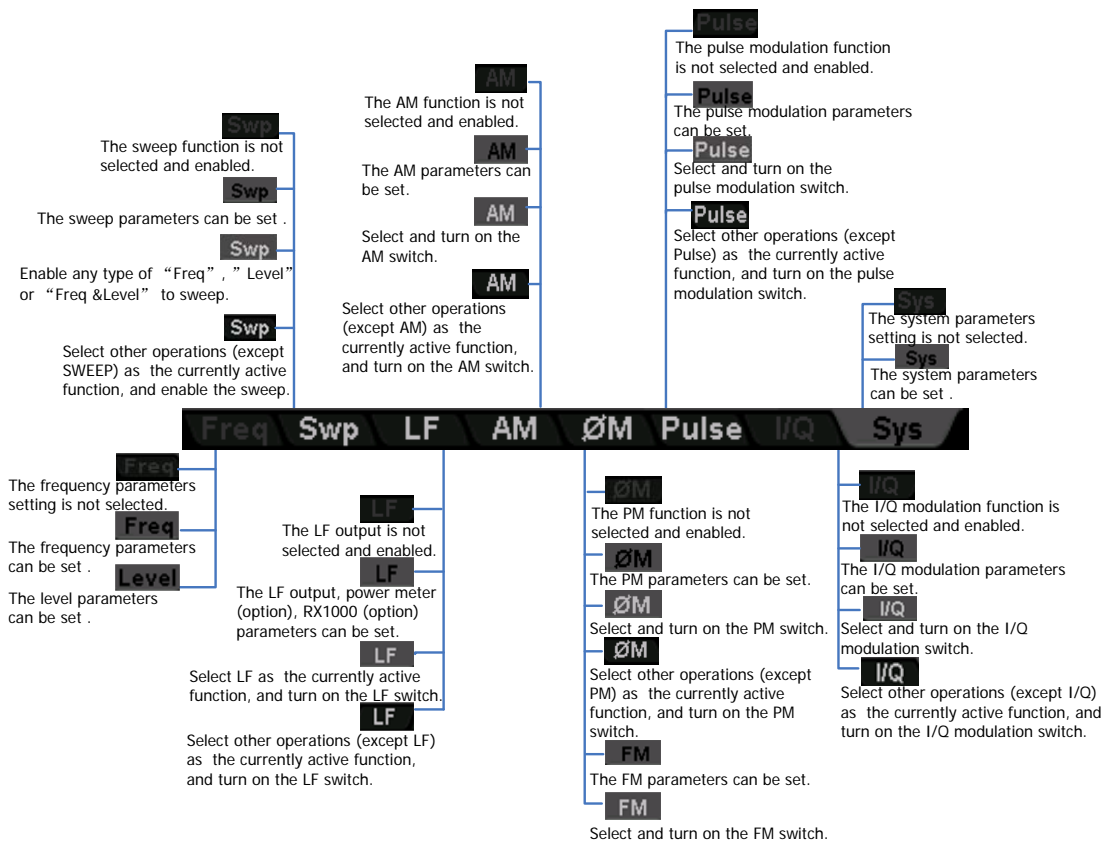

Figure 1-9 Labels in Function Status Area

7. Text Display Area

Display the corresponding parameter information of the current function of the RF signal generator.

Parameter Zoom-in Mode

In normal display mode, pressing the display switch key **View** at the left of the screen can switch to the parameter zoom-in mode as shown in the figure below.

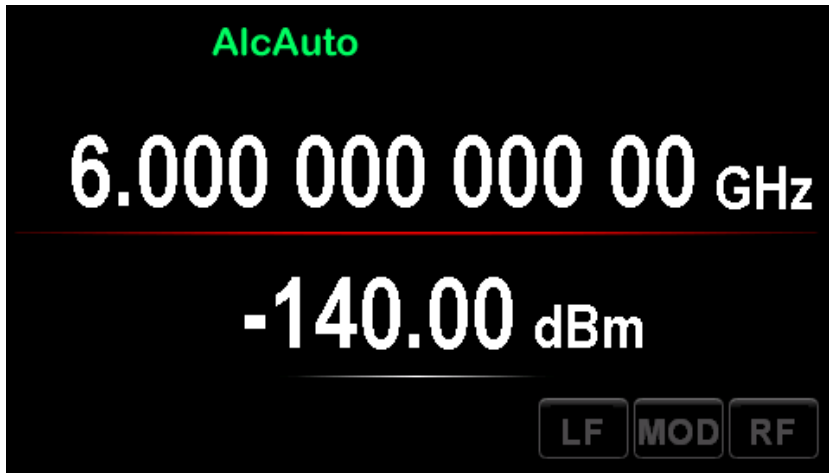

Figure 1-10 User Interface (Parameter Zoom-in Mode)

To Use the Built-in Help System

The DSG3000 built-in help system provides help information for all the function keys and menu softkeys located on the front panel. Users can view the help of any key when operating the instrument.

1. Acquire the built-in help

Press **Help** and the prompt message about how to acquire the help information is displayed in the test display area of the user interface, as shown in Figure 1-11. Then, press the desired key and the help information of that key is displayed in the text display area.

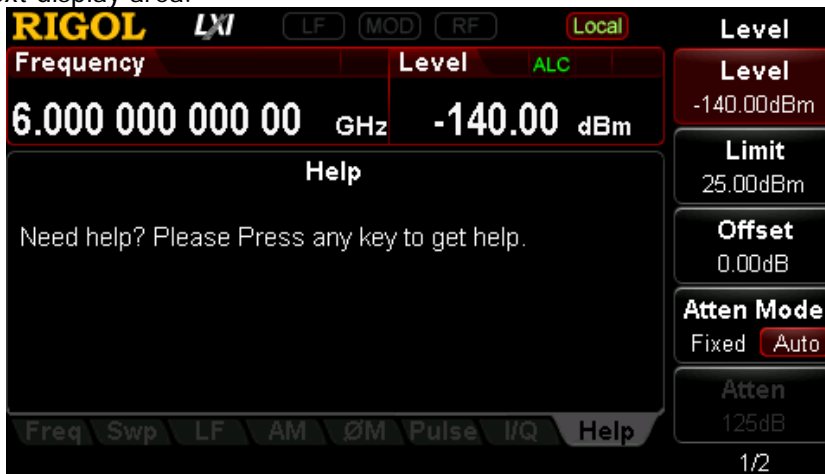

Figure 1-11 Help Interface

2. Page up/down

When the help information is displayed on multiple pages, users can acquire the help information on the previous or next page using the direction keys or knob.

3. Turn off the current help information

When the help information is displayed in the text display area, pressing any key (except the direction keys and knob) at the front panel will turn off the help information currently displayed.

4. Acquire the help information of a menu softkey

Press **Help** and help information is displayed in the text display area. Then, press the desired menu softkey, the help information of the menu item corresponding to this menu softkey is displayed in the text display area.

5. Acquire the help information of any function key

Press **Help** and help information is displayed in the text display area. Then, press any function key and the function help information of this key is displayed in the text display area.

Chapter 2 Front Panel Operations

This chapter introduces each function key at the front panel as well as the menu functions under it in details.

The contents of this chapter are as follows:

- To Set the Frequency Parameters
- To Set the Amplitude Parameters
- Sweep
- Modulation
- LF Output
- Store and Recall
- To Set the System Parameters

To Set the Frequency Parameters

Frequency

Set the RF output frequency.

Press **FREQ** → **Frequency**, use the numeric keyboard to input the value of the frequency and select the desired unit from the pop-up unit menu or unit keys.

- The frequency units available are GHz, MHz, kHz and Hz.
- Press **Enter** to select the default unit (Hz).
- You can also press the left/right direction keys to enter the parameter editing state and move the cursor to the specified digit; and then use the up/down direction keys or knob to modify the value.
- After the frequency is set, you can use the up/down direction keys or knob to modify the frequency at the current step.
- Press **FREQ** → **Frequency** and then press **Step** to set the step.

Frequency Offset

Set the frequency offset relative to the RF output frequency.

When using an external mixer and other devices, you can set and read the frequency value through the external mixer on the RF source by setting the frequency offset.

Press **FREQ** → **Offset**, use the numeric keyboard to input the value of the frequency offset and select the desired unit from the pop-up unit menu or unit keys.

- The frequency offset units available are GHz, MHz, kHz and Hz.
- Press **Enter** to select the default unit (Hz).
- You can also press the left/right direction keys to enter the parameter editing state and move the cursor to the specified digit; and then use the up/down direction keys or knob to modify the value.
- You can also use the up/down direction keys or knob to modify the frequency offset at the current step.
- Press **FREQ** → **Offset** and then press **Step** to set the step.

Explanation

1. When the frequency offset is 0 Hz, the frequency displayed in the interface (namely setting frequency) is equal to the actual output frequency.
2. When frequency offset is not 0 Hz, the output frequency is determined by setting frequency and frequency offset. The three parameters satisfy the equation: setting frequency (display frequency) = output frequency + frequency offset
3. The deviation (namely the actual output frequency) between interface display frequency and frequency offset cannot exceed the frequency range of instrument.

Phase Offset

Set the phase offset of the RF signal.

When multiple RF signal generators are used to output signals, you can adjust the phase offset of the instrument to synchronize the phase or set a fixed phase offset for the signals.

Press **FREQ** → **Phase Offset**, after that use the numeric keyboard to input the value of the phase offset and press **deg** or the unit key.

- Press **Enter** to select the default unit (deg).
- Press the left/right direction keys to enter the parameter editing state.
- You can also use the up/down direction keys or knob to modify the phase offset at the current step.
- Press **FREQ** → **Phase Offset** and then press **Step** to set the step.
- Press **Rst Phase** to reset the current phase offset to 0 deg.

To Set the Amplitude Parameters

Amplitude

Set the RF output amplitude.

Press **LEVEL** → **Level**, use the numeric keyboard to input the amplitude value and select the desired unit from the pop-up unit menu or unit keys.

- The amplitude units available are dBm, -dBm, mV, μ V and nV.
- Press **Enter** to select the default unit (dBm).
- You can also press the left/right direction keys to enter the parameter editing state and move the cursor to the specified digit and then use the up/down direction keys or knob to modify the value.
- You can also use the up/down direction keys or knob to modify the amplitude at the current step.
- Press **LEVEL** → **Level** and then press **Step** to set the step.

Amplitude Limit

Set the limit of the RF output amplitude. This value is the upper limit of the RF output amplitude.

To limit the output amplitude, you can use the amplitude limit function to avoid damage caused by delivering a high powered signal to the external circuit.

Press **LEVEL** → **Limit**, use the numeric keyboard to input the value of the amplitude limit and select the desired unit from the pop-up unit menu or unit keys.

- The amplitude limit units available are dBm, -dBm, mV, μ V and nV.
- Press **Enter** to select the default unit (dBm).
- You can also press the left/right direction keys to enter the parameter editing state and move the cursor to the specified digit; and then use the up/down direction keys or knob to modify the value.
- You can also use the up/down direction keys or knob to modify the amplitude limit at the current step.
- Press **LEVEL** → **Limit** and then press **Step** to set the step.

Amplitude Offset

Set the amplitude offset relative to the RF output amplitude.

If the external device or circuit has a fixed attenuation or gain, you can set and read the amplitude value after through the external device or circuit on the RF source by setting the amplitude offset.

Press **LEVEL** → **Offset**, use the numeric keyboard to input the amplitude offset value and press **dB** or the unit key.

- The amplitude offset unit available is dB.
- Press **Enter** to select the default unit (dB).
- You can also press the left/right direction keys to enter the parameter editing state and move the cursor to the specified digit and then use the up/down direction keys or knob to modify the value.
- You can also use the up/down direction keys or knob to modify the amplitude offset at the current step.
- Press **LEVEL** → **Offset** and then press **Step** to set the step.

Explanation

1. When amplitude offset is 0 Hz, the amplitude displayed in the interface (namely setting amplitude) is equal to the actual output amplitude.
2. When amplitude offset is not 0 Hz, output amplitude is determined by setting amplitude and amplitude offset. The three parameters satisfy the equation: setting amplitude (display amplitude) = output amplitude + amplitude offset
3. The deviation (namely the actual output amplitude) between interface display amplitude and amplitude offset cannot exceed the amplitude range of instrument.
4. The current amplitude range of instrument is determined by amplitude limit, attenuation mode, attenuation value and RF output frequency.

Attenuation Mode

Set the attenuation mode of RF output.

If you want to get a larger amplitude setting range, you can set the attenuation mode to auto. If you want to get higher amplitude accuracy in a smaller amplitude range, you can set the attenuation mode to fixed.

Press **LEVEL** → **Atten Mode** to set the attenuation mode of the RF output amplitude to “Auto” or “Fixed”.

- Auto: the default mode. In this mode, the attenuator adjusts the attenuation automatically to match the current amplitude setting. Therefore, you can set the amplitude within the whole range.
- Fixed: in this mode, the attenuation is the value set in **Atten**. Therefore, you can only set the amplitude within a certain range. At this point, if the ALC is enabled, you can set the amplitude within a certain range continuously. Please refer to “**Specifications**”. The AH label is displayed in the amplitude area in the user interface.

Explanation

When the attenuation mode of the RF output amplitude is auto, the internal attenuator provides attenuation for the output amplitude to get a larger dynamic output range.

Attenuation

Set the attenuation of the RF output amplitude in fixed attenuation mode.

Press **LEVEL** → **Atten Mode** to select “Fixed”; press **Atten**, use the numeric keyboard to input the amplitude attenuation value and press **dB** or the unit key.

- The amplitude attenuation unit available is dB.
- Press **Enter** to select the default unit (dB).
- You can also press the left/right direction keys to enter the parameter editing state and move the cursor to the specified digit and then use the up/down direction keys or knob to modify the value.
- You can also use the up/down direction keys or knob to modify the amplitude offset at the current step.
- Press **Step** to set the step.

ALC

Set the working state of the ALC function.

ALC is the automatic level control function. This function compares the actual output amplitude with the set amplitude and adjusts the output amplitude according to the comparison result to ensure the accuracy of the output amplitude.

Press **LEVEL** and use the menu page up/down key  to open the 2/2 menu page. Press **ALC** to select "Off", "On" or "Auto".

- Off: turn off the ALC function.
- On: turn on the ALC function and the ALC label is displayed in the amplitude area in the user interface.
- Auto: turn on or off the function automatically according to the current state of the instrument and the ALC label is displayed in the amplitude area in the user interface.

Hold Mode

Set the hold mode of RF output amplitude.

When ALC is disabled, the instrument switches to "Sample & Hold" state. At this point, the RF signal generator samples and holds the amplitude setting values with ALC turned on. This allows the generator to maintain a constant output level.

Press **LEVEL** → **S&H Mode** to select "Manul" or "Auto".

- Manul: in this mode, the instrument performs a sample and hold operation each time **S&H** is pressed.
- Auto: the default mode. In this mode, the instrument performs a sample and hold operation each time the RF amplitude is set. In addition, you can also press **S&H** to perform an operation.

NOTE: The above-mentioned menus are valid only when ALC function is "off".

Flatness Calibration

The flatness calibration function can adjust RF output amplitudes corresponding to the frequency points within the frequency range of the instrument to compensate for the external loss caused by cabling, switches or other devices. You can create the flatness calibration list and store the calibration list in internal or external memory. You can also recall the stored calibration list when required.

1. Set the flatness calibration state

Press **LEVEL** and use the page up/down key  to open the 2/2 menu page; then, press **Flatness** → **Switch** to set the flatness calibration to “On” or “Off”. When the flatness calibration is enabled, the UF label will be displayed in the amplitude area in the user interface.

2. Create the flatness calibration list

Press **LEVEL** → **Flatness** → **Cal List** to enter the editing interface of flatness calibration list.

SN	Row number. You can use Insert and Delete to add and delete rows.
Freq	Frequency. The flatness calibration list can contain the amplitude calibration values of up to 6000 frequency points. The 6000 frequency points can locate in any frequency segment within the maximum frequency range available. You can save calibration lists applicable to different test settings or frequency ranges and recall different calibration list when required.
Level	Amplitude calibration value. When calibrating the amplitude of the current frequency point, only the actual output amplitude will be affected and the amplitude display value will not change.

- **Insert**
Press **Insert** to insert a row with the same calibration value below the current row. At this point, the number of rows of the flatness calibration list increases by one.
- **Delete**
Press **Delete** to delete the calibration value of the row currently selected. At this point, the number of rows of the flatness calibration list reduces by one.
- **Goto Row**
Press **Goto Row** to select the desired row for editing in the pop-up menu. It is usually used to modify the calibration value of the specified row.

N: press **n** and use the numeric keyboard to input the desired row number to select that row. The row number input should not be greater than the total number of rows of the current list.

Top: press **Top** to select the first row of the current list.

Mid: press **Mid** to select the row at the middle of the current list.

Bottom: press **Bottom** to select the last row of the current list.

When the desired row is selected, press  to return to the previous menu to modify the calibration value of the row currently selected.

- **Load**
Press **Load** to open the store and recall interface. At this point, you can select and read the flatness calibration list file stored. For detailed operations, refer to the introduction in "**Store and Recall**". You can edit or modify the calibration list recalled.
- **Store**
Press **Store** to open the store and recall interface. At this point, you can save the flatness calibration list file currently edited. For the detailed operations, please refer to the introduction in "**Store and Recall**".

Tips

Edit flatness calibration list:

- 1) Use the direction keys or knob to select the frequency and amplitude of the point to be set in the calibration list;
- 2) Press the numeric keyboard to input the value and select the desired unit from the pop-up unit menu or unit keys. You can also press **Enter** to select the default unit Hz or dB.

3. Calibrate the flatness calibration list

When a USB power meter is connected to DSG3000 and the power meter controller (option) is activated, the menu is lit under **LEVEL** → **Flatness** → **Calibration**. You can use the power meter to measure the data in the flatness calibration list.

- **Set the state of measuring flatness list**
Press **Switch** to select "On" or "Off".
 - On: enable the measuring flatness list function with power meter.
 - Off: disable the measuring flatness list function with power meter.
- **Dwell time**
Press **Dwell time** to set the duration of each point when sweeping the flatness list.

Amplitude Unit

Set the unit of the RF output amplitude.

Press **LEVEL** and use the page up/down key  to open the 2/2 menu page; then, press **Level Unit** and select the desired unit from the pop-up unit menu. The output amplitude units available are dBm, dBmV, dBuV, Volts and Watts. Wherein, dBm, dBmV and dBuV are logarithmic units. Volts and Watts are linear units. The default is dBm.

Sweep

When the sweep function is enabled, the RF signal generator outputs RF sweep signal from the **[RF OUTPUT 50Ω]** connector (as shown in the figure below) at the front panel (at this point, RF output switch is turned on).

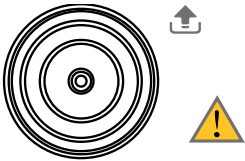

RF OUTPUT 50Ω

Sweep Manner

DSG3000 provides three sweep manners ("Freq", "Level" and "Freq & Lev"). The sweep function is enabled when any of the sweep manners is selected and the Swp label will be displayed in the function status area in the user interface. By default, the sweep function is turned off.

Press **[SWEEP]** → **Sweep** to select the desired manner.

- Off: the default state. Turn off the sweep function.
- Freq: enable the frequency sweep function. At this point, the frequency sweep progress bar is displayed in the frequency area in the user interface.
- Level: enable the amplitude sweep function. At this point, the amplitude sweep progress bar is displayed in the amplitude area in the user interface.
- Freq & Lev: enable the frequency and amplitude sweep functions at the same time. At this point, the frequency and amplitude sweep progress bars are displayed in the frequency and amplitude areas in the user interface respectively.

Sweep Direction

Press **[SWEEP]** and use the page up/down key  to open the 3/3 menu page; then, press **Direct** to select "Fwd" or "Down" and the default is "Fwd".

- Fwd: the RF signal generator sweeps from the start frequency or start level to the stop frequency or stop level. The progress bar in the frequency area and amplitude area in the user interface sweeps from left to right.
- Down: the RF signal generator sweeps from the stop frequency or stop level to the start frequency or start level. The progress bar in the frequency area and amplitude area in the user interface sweeps from right to left.

Sweep Type

DSG3000 provides two sweep types (“List” and “Step”) and the default is “Step”.

List Sweep

1. Select the list sweep mode

Press **SWEEP** → **Type** to select “List”. At this point, the RF signal generator sweeps according to the current sweep list.

2. Create the sweep list

Press **SWEEP** and use the page up/down key  to open the 2/3 menu page; then, press **List Swp** to enter the editing interface of sweep list.

SN	Line number. You can add and delete rows using Insert and Delete .
Freq	Frequency. The sweep list can contain up to 6001 frequency points. These frequency points can locate in any frequency segment within the maximum frequency range available. You can save sweep lists applicable to different test settings or frequency ranges and recall different sweep list when required.
Level	Amplitude. It is the corresponding amplitude value of the frequency point. The sweep list can contain up to 6001 level points.
Time	Dwell time. The duration of a sweep step.

- Amplitude Calibration

Press **Amp Cal**, you can turn on or turn off the measuring sweep list function with power meter. At this point, you can also record the error value.

NOTE: The menu is activated when a USB power sensor is connected and power meter controller (option) is installed, otherwise the menu is grayed out and disabled.

- Insert

Press **Insert** to insert a row with the same sweep values below the current row. At this point, the number of rows of the sweep list increases by one.

- Delete

Press **Delete** to delete the sweep values of the row currently selected. At this point, the number of rows of the sweep list reduces by one.

- Goto Row

Press **Goto Row** to select the desired row for edit in the pop-up menu. It is

usually used to modify the sweep values of the specified row. You can also perform delete or insert operation on the row selected.

N: press **n** and use the numeric keyboard to input the desired row number to select that row. The row number input should not be greater than the total number of rows of the current list.

Top: press **Top** to select the first row of the current list.

Mid: press **Mid** to select the row at the middle of the current list.

Bottom: press **Bottom** to select the last row of the current list.

When the desired row is selected, press  to return to the previous menu to modify the sweep values of the row currently selected.

- Preset List

Press **Preset List** to select "Default" or "StepSwp".

Default: restore to the default setting list. At this point, the sweep list only contains one frequency point (6 GHz) and level point (-130 dBm). You can re-edit the current sweep list.

StepSwp: generate the sweep list according to the current reference values set in "**Step Sweep**".

- Load

Press **Load** to open the store and recall interface. At this point, you can select and read the sweep list file stored. For detailed operations, refer to the introduction in "**Store and Recall**".

You can edit or modify the sweep list recalled.

- Store

Press **Store** to open the store and recall interface. At this point, you can save the sweep list file currently edited. For the detailed operations, please refer to the introduction in "**Store and Recall**".

Tips

Edit sweep list:

You can use the direction keys or knob to select the frequency, amplitude and time of the point to be set, use the numeric keyboard to input the value and select the desired unit from the pop-up unit menu or unit keys. You can also press **Enter** to select the default unit Hz, dBm or s.

Step Sweep

1. Select the step sweep mode

Press **SWEEP** → **Type** to select "Step". At this point, the RF signal generator performs a step sweep according to the current settings.

2. Set the sweep parameters

Press **SWEEP** and use the page up/down key  to open the 2/3 menu page; then, press **Step Swp** to set the start frequency, stop frequency, start level, stop level, sweep points and so on.

- Start Frequency
Press **Start Freq**, use the numeric keyboard to input the start frequency value and select the desired unit from the pop-up unit menu or unit keys. You can also press **Enter** to select the default unit (Hz).
- Stop Frequency
Press **Stop Freq**, use the numeric keyboard to input the stop frequency value and select the desired unit from the pop-up unit menu or unit keys. You can also press **Enter** to select the default unit (Hz).

Explanation

The start frequency and stop frequency are the frequency upper and lower limits of the frequency sweep.

- When the sweep direction is forward, the RF signal generator sweeps from the start frequency to the stop frequency.
- When the sweep direction is down, the RF signal generator sweeps from the stop frequency to the start frequency.

When the "Start Freq" or "Stop Freq" is modified, the RF signal generator will restart the sweep and output from the specified "Start Freq" or "Stop Freq".

- Start Level
Press **Start Lev**, use the numeric keyboard to input the start level value and select the desired unit from the pop-up unit menu or unit keys. You can also press **Enter** to select the default unit (dBm).
- Stop Level
Press **Stop Lev**, use the numeric keyboard to input the stop level value and select the desired unit from the pop-up unit menu or unit keys. You can also press **Enter** to select the default unit (dBm).

Explanation

The start level and stop level are the amplitude upper and lower limits of the amplitude sweep.

- When the sweep direction is forward, the RF signal generator sweeps from the start level to the stop level.
- When the sweep direction is down, the RF signal generator sweeps from the stop level to the start level.

When the "Start Lev" or "Stop Lev" is modified, the RF signal generator will restart the sweep and output from the specified "Start Lev" or "Stop Lev".

- Sweep Points

Press **Points**, use the numeric keyboard to input the number of sweep points and then press **OK** or **Enter**.

- Dwell Time

The dwell time indicates the duration of a sweep step.

Press **Dwell Time**, use the numeric keyboard to input the time value and select the desired unit from the pop-up unit menu or unit keys. You can also press **Enter** to select the default unit (s).

- Sweep Space

The sweep space indicates the mode in which the instrument changes from one frequency or amplitude to another within one step.

Press **Swp Space** to select "Log" or "Lin" sweep space.

- Sweep Shape

The sweep shape indicates the cycle mode of multiple sweeps.

Press **Shape** to select "Ramp" or "Triangle" sweep shape. When the sweep direction is "Fwd", the "Ramp" and "Triangle" sweep shapes are as shown in the figure below.

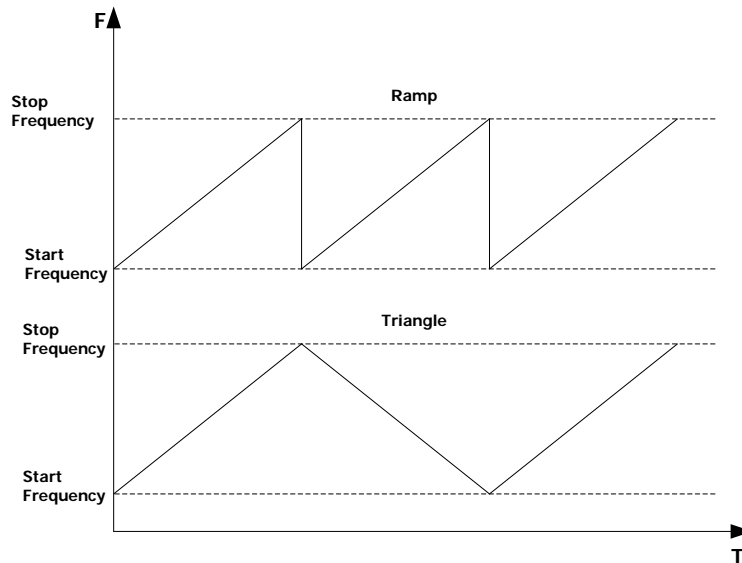

Ramp: the sweep period always starts from the start frequency or start level to the stop frequency or stop level and the sweep sequence is similar to a ramp waveform.

Triangle: the sweep period always starts from the start frequency or start level to the stop frequency or stop level and then returns back to the start frequency or start level. The sweep sequence is similar to a triangle waveform.

Sweep Mode

Press **SWEEP** → **Mode** to select "Cont" or "Single" sweep and the default is "Cont".

- **Cont:** after selecting continuous sweep, the continuous sweep label is displayed in the frequency or amplitude area in the user interface. When the trigger condition is met, the instrument starts to sweep continuously according to the current setting.
- **Single:** after selecting single sweep, the single sweep label is displayed in the frequency or amplitude area in the user interface. When the trigger condition is met, the instrument performs one sweep according to the current setting and then stops.

Single Sweep

If the current sweep mode is "Cont", press **Single** to switch the sweep mode to "Single" and the instrument will perform one sweep if the trigger condition is met. If the current sweep mode is "Single", press **Single** and the instrument will perform one sweep if the trigger condition is met.

Reset Sweep

If the current sweep direction is "Fwd", press **Reset Swp**, the instrument stops the current sweep and restarts the sweep from the start frequency or start level. If the current sweep direction is "Down", press **Reset Swp**, the instrument stops the current sweep and restarts the sweep from the stop frequency or stop level.

Trigger Mode

1. Trigger Mode

Select the trigger mode of the whole sweep period.

Press **SWEEP** and use the page up/down key  to open the 2/3 menu page; then, press **Trig Mode** to select "Auto", "Key", "Bus" or "Ext" trigger.

NOTE: The following descriptions are valid when the trigger mode of each point in the sweep period is met.

- Auto Trigger
The default mode is auto. If the sweep mode is set to "Cont", the instrument will start sweeping once a sweep type is selected. If the sweep mode is set to "Single", press **Single** to meet the single sweep condition. The instrument will start a sweep and then stops.
- Key Trigger
After selecting "Key" trigger, if the sweep mode is set to "Cont", the instrument starts a sweep each time **Trigger** at the front panel is pressed. If the sweep mode is "Single", press **Single** to meet the single sweep condition. After that the instrument starts a sweep and then stops each time **Trigger** at the front panel is pressed.
- Bus Trigger
After selecting "Bus" trigger, if the sweep mode is set to "Cont", the instrument starts a sweep each time the "*TRG" command is sent. If the sweep mode is "Single", press **Single** to meet the single sweep condition. After that the instrument starts a sweep and then stops each time the

"*TRG" command is sent.

- External Trigger

In external trigger, the RF signal generator accepts the trigger signal input from the **[TRIGGER IN]** connector (as shown in the figure below) at the rear panel. If the sweep mode is set to "Cont", the instrument starts a sweep each time a TTL pulse signal with specified polarity is received. If the sweep mode is "Single", press **Single** to meet the single sweep condition. After that the instrument starts a sweep and then stops each time a TTL pulse signal with the specified polarity is received.



To specify the polarity of the TTL pulse signal, press **Trig Slope** to select "Pos" or "Neg" and the default is "Pos".

2. Point Trigger Mode

Select the trigger mode of each sweep point in a sweep period.

Press **[SWEEP]** and use the page up/down key  to open the 2/3 menu page; then, press **Point Trig** to select "Auto", "Key", "Bus" or "Ext" trigger.

NOTE: The following descriptions are valid when the corresponding trigger mode of sweep period is met.

- Auto Trigger

The default mode is auto. If the sweep mode is set to "Cont", the instrument will start sweeping each sweep point continuously within a sweep period once a sweep type is selected. If the sweep mode is set to "Single", press **Single** to meet the single sweep condition. After that the instrument starts to sweep and then stops after the sweep period is finished.

- Key Trigger

After selecting "Key" trigger, if the sweep mode is set to "Cont", the instrument starts to sweep a point each time **[Trigger]** at the front panel is pressed. If the sweep mode is "Single", press **Single** to meet the single sweep condition. At this point, the instrument starts to sweep a point and stops after the sweep period is finished each time **[Trigger]** at the front panel is pressed.

- **Bus Trigger**
After selecting "Bus" trigger, if the sweep mode is set to "Cont", the instrument starts to sweep a point each time the "*TRG" command is sent. If the sweep mode is "Single", press **Single** to meet the single sweep condition. At this point, the instrument starts to sweep a point and stops after the sweep period is finished each time the "*TRG" command is sent.
- **External Trigger**
In external trigger mode, the RF signal generator accepts the trigger signal input from the **[TRIGGER IN]** connector (as shown in the figure below) at the rear panel. If the sweep mode is set to "Cont", the instrument starts to sweep a point each time a TTL pulse signal with specified polarity is received. If the sweep mode is "Single", press **Single** to meet the single sweep condition. At this point, the instrument starts to sweep a point and stops after the sweep period is finished each time a TTL pulse signal with specified polarity is received.



To specify the polarity of the TTL pulse signal, press **Trig Slope** to select "Pos" or "Neg" and the default is "Pos".

Explanation

When executing the sweep operation, the priority order of the conditions is Single Sweep → Trigger Mode → Point Trigger Mode. For example, when both the trigger mode and point trigger mode are set to "Key" trigger:

- In "Cont" sweep mode, press **Trigger** to meet the trigger mode of the whole period and then press **Trigger** again to meet the trigger mode of points within the sweep period; then, the instrument starts to sweep.
- In "single" sweep mode, press **Single** to meet the single sweep condition and then press **Trigger** twice to meet the sweep period trigger mode and point trigger mode respectively. Then, the instrument starts to sweep.

Modulation

Amplitude Modulation (AM)

During amplitude modulation (AM), the modulating signal changes the amplitude of the RF carrier waveform linearly.

To Enable AM

Press **AM** → **Switch** to select "On" or "Off".

- On: enable the AM function. The backlight of **AM** goes on and the AM label is displayed in the function status area in the user interface.
- Off: disable the AM function and this is the default state.

To Select the Modulation Source

Press **AM** → **Source** to select "Int", "Ext" or "Int & Ext" modulation source.

1. Internal Source

After selecting "Int", the internal modulation source is turned on. At this point, the instrument provides the modulating signal and you can set the modulation frequency and modulation waveform of the modulating signal.

2. External Source

After selecting "Ext", **Freq** and **Waveform** are grayed out and disabled. The RF signal generator receives the external modulating signal input from the **[EXT MOD INPUT]** connector (as shown in the figure below) at the front panel. This modulating signal can be any waveform.



EXT MOD INPUT

NOTE: The input amplitude of external modulating signal reaches +/-3V.

3. Internal & External

After selecting "Int & Ext", both internal and external modulating sources are selected at the same time and you can perform dual-tone AM signal modulation.

To Set the Modulation Depth

The modulation depth indicates the extent of output amplitude variation and is expressed as a percentage. The range of AM modulation depth is from 0% to 100%.

Press **AM** → **Depth** to set the AM modulation depth.

1. Select “Int” modulation source

AM modulation depth (m_a) and the amplitude difference (ΔP_{sb}) between the carrier and sidebands satisfy the following relation:

$$\Delta P_{sb} = 6 - 20 \lg m_a$$

- When modulation depth is 0%, the instrument outputs a single frequency carrier signal.
- The greater the modulation depth is, the smaller the difference between the output amplitude and carrier amplitude and the better the symmetry of the output amplitudes of the upper and lower sidebands.

2. Select “Ext” modulation source

- To achieve a modulation depth of 100%, the external modulation source must input a signal (-1V to +1V).
- If the external modulation source inputs a signal (-500mV to +500mV), the measured modulation depth is 50%.

3. Select “Int & Ext” modulation source

If modulation depth is set to 50%, the modulation depth of the internal modulation source and that of the external modulation source each is 25% respectively. These parameters meet the relationship: the modulation depth setting = the internal modulation depth + the external modulation depth, and the modulation depth of the internal modulation source equals that of the external modulation source.

To Select the Modulation Waveform

Press **AM** → **Source** to select “Int” or “Int & Ext” modulation source; press **Waveform** to select “Sine” or “Square” and the default is “Sine”.

NOTE: When “Ext” modulation source is selected, this menu is grayed out and disabled.

To Set the Modulation Frequency

Press **AM** → **Source** to select “Int” or “Int & Ext” modulation source; press **Freq** to set the frequency of the modulating waveform.

- Use the numeric keyboard or knob to input the desired frequency value.
- For sine waveforms, the range of the modulation frequency is from 100 mHz to 1 MHz.
- For square waveforms, the range of the modulation frequency is from 100 mHz to 20 kHz.

NOTE: When “Ext” modulation source is selected, this menu is grayed out and disabled.

Frequency Modulation (FM)

During frequency modulation (FM), the modulating signal changes the frequency of the RF carrier waveform.

To Enable FM

Press **FM/øM** → **FM/øM** to select "FM" and press **Switch** to select "On" or "Off".

- On: enable the FM function. The backlight of **FM/øM** goes on and the FM label is displayed in the function status area in the user interface.
- Off: disable the FM function and this is the default state.

NOTE: The frequency modulation and phase modulation cannot be enabled at the same time.

To Select the Modulation Source

Press **FM/øM** → **Source** to select "Int", "Ext" or "Int & Ext" modulation source.

1. Internal Source

After selecting "Int", the internal modulation source is turned on. At this point, the instrument provides the modulating signal and you can set the modulation frequency and modulation waveform of the modulating signal.

2. External Source

After selecting "Ext", **Rate** and **Waveform** are grayed out and disabled. The RF signal generator receives the external modulating signal input from the **[EXT MOD INPUT]** connector (as shown in the figure below) at the front panel. This modulating signal can be any waveform.



EXT MOD INPUT

NOTE: The input amplitude of external modulating signal reaches +/-3V.

3. Internal & External

After selecting "Int & Ext", both internal and external modulating sources are selected at the same time and you can perform dual-tone FM signal modulation.

To Set the Frequency Deviation

The frequency deviation is the deviation of the frequency of the modulating waveform relative to that of the carrier waveform and the unit is Hz.

Press **FM/øM** → **Deviation** to set the FM frequency deviation.

- Use the numeric keyboard or knob to input the desired frequency value.
- The different RF frequency setting corresponds to different maximum frequency deviation.

To Select the Modulation Waveform

Press **FM/øM** → **Source** to select “Int” or “Int & Ext” modulation source; use the page up/down key  to open the 2/2 menu page and press **Waveform** to select “Sine” or “Square” and the default is “Sine”.

NOTE: When “Ext” modulation source is selected, this menu is grayed out and disabled.

To Set the Modulation Frequency

Press **FM/øM** → **Source** to select “Int” or “Int & Ext” modulation source; press **Rate** to set the frequency of the modulating waveform.

- Use the numeric keyboard or knob to input the desired frequency value.
- For sine waveforms, the range of the modulation frequency is from 100 mHz to 1 MHz.
- For square waveforms, the range of the modulation frequency is from 100 mHz to 20 kHz.

NOTE: When “Ext” modulation source is selected, this menu is grayed out and disabled.

Phase Modulation (Φ M)

During phase modulation (Φ M), the modulating waveform changes the phase of the RF carrier waveform.

To Enable Φ M

Press **FM/ Φ M** → **FM/ Φ M** to select " Φ M" and press **Switch** to select "On" or "Off".

- On: enable the Φ M function. The backlight of **FM/ Φ M** goes on and the Φ M label is displayed in the function status area in the user interface.
- Off: disable the Φ M function and this is the default state.

NOTE: The frequency modulation and phase modulation cannot be enabled at the same time.

To Select the Modulation Source

Press **FM/ Φ M** → **Source** to select "Int", "Ext" or "Int & Ext" modulation source.

1. Internal Source

After selecting "Int", the internal modulation source is turned on. At this point, the instrument provides the modulating signal and you can set the modulation frequency and modulation waveform of the modulating signal.

2. External Source

After selecting "Ext", **Rate** and **Waveform** are grayed out and disabled. The RF signal generator receives the external modulating signal input from the **[EXT MOD INPUT]** connector (as shown in the figure below) at the front panel. This modulating signal can be any waveform.



EXT MOD INPUT

NOTE: The input amplitude of external modulating signal reaches +/-3V.

3. Internal & External

After selecting "Int & Ext", both internal and external modulating sources are selected at the same time and you can perform dual-tone Φ M signal modulation.

To Set the Phase Deviation

The phase deviation is the deviation of the phase of the modulating waveform relative to that of the carrier waveform and the unit is rad.

Press **FM/øM** → **Deviation** to set the øM phase deviation.

- Use the numeric keyboard or knob to input the desired phase value.
- The different RF frequency setting corresponds to different maximum phase deviation.

To Select the Modulation Waveform

Press **FM/øM** → **Source** to select “Int” or “Int & Ext” modulation source; use the page up/down key  to open the 2/2 menu page and press **Waveform** to select “Sine” or “Square” and the default is “Sine”.

NOTE: When “Ext” modulation source is selected, this menu is grayed out and disabled.

To Set the Modulation Frequency

Press **FM/øM** → **Source** to select “Int” or “Int & Ext” modulation source; press **Rate** to set the frequency of the modulating waveform.

- Use the numeric keyboard or knob to input the desired frequency value.
- For sine waveforms, the range of the modulation frequency is from 100 mHz to 1 MHz.
- For square waveforms, the range of the modulation frequency is from 100 mHz to 20 kHz.

NOTE: When “Ext” modulation source is selected, this menu is grayed out and disabled.

Pulse Modulation

During pulse modulation, the RF carrier waveform is modulated by the pulse signal.

To Enable Pulse Modulation

Press **Pulse** → **Switch** to select “On” or “Off”.

- On: enable the pulse modulation function. The backlight of **Pulse** goes on and the Pulse label is displayed in the function status area in the user interface.
- Off: disable the pulse modulation function and this is the default state.

To Select the Modulation Source

Press **Pulse** → **Source** to select “Ext” or “Int” modulation source.

1. Internal Source

After selecting “Int”, the internal modulation source is turned on. At this point, the instrument provides the modulating signal and you can set the pulse mode, pulse period and pulse width of the modulating signal.

2. External Source

After selecting “Ext”, **Mode**, **Period**, **Width Trig Mode** and **Pulse Out** are grayed out and disabled. The RF signal generator receives the external pulse signal input from the **[PULSE IN/OUT]** connector (as shown in the figure below) at the rear panel as the modulating signal.

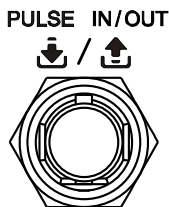

To Select the Pulse Mode

Press **Pulse** → **Source** to select "Int" modulation source; press **Mode** to select "Single", "Double" or "Train" (option PUG-DSG3000).

- Single: only one pulse signal is generated for a pulse period. This is the default pulse mode.
- Double: two pulse signals are generated for a pulse period. At this point, **Delay** and **#2 Width** are available and you can set the delay and pulse width.
- Train: a plurality of pulse signals are generated for a pulse period. At this point, **Period**, **Width**, **Delay** and **#2 Width** are grayed out and disabled. You can press **Train List** to edit the desired pulse train.

NOTE: When "Ext" modulation source is selected, this menu is grayed out and disabled. When selecting "Train" or editing "Train List", you need to install the option PUG-DSG3000. For the specific installation steps, please refer to *DSG3000 Firmware and Options Installation Instruction*.

To Set the Pulse Period

The pulse period is the time interval between two neighboring pulses in periodically-repeating pulse sequence.

Press **Pulse** → **Source** to select "Int" modulation source; press **Period** to set the period of the pulse modulating signal.

- Use the numeric keyboard to input the desired value and select the desired unit from the pop-up unit menu or unit keys. You can also press **Enter** to select the default unit (s).
- You can also use the knob to modify this parameter.
- The range of pulse period is from 40 ns to 170 s.
- The pulse period determines the repeating frequency of the internal pulse modulating signal.

NOTE: When "Ext" modulation source or "Train" pulse mode is selected, this menu is grayed out and disabled.

To Set the Pulse Width

The pulse width is the time that the pulse can hold at the maximum value.

Press **Pulse** → **Source** to select "Int" modulation source; press **Mode** to select "Single" or "Double". At this point, you can set the corresponding pulse width and delay.

NOTE: For “Train” pulse width and the related parameter settings, please refer to “Pulse Train List”.

1. Single Pulse

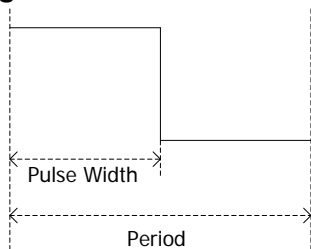

Press **Width** to set the width of the single-pulse modulating signal.

- Use the numeric keyboard or knob to input the desired pulse width value.
- The range of the pulse width is from 10 ns to 170 s – 10 ns.
- The pulse width is limited by the minimum pulse width and pulse period.
 $\text{Pulse Width} \geq \text{Minimum Pulse Width}$
 $\text{Pulse Width} \leq \text{Pulse Period} - 10 \text{ ns}$

2. Double Pulse

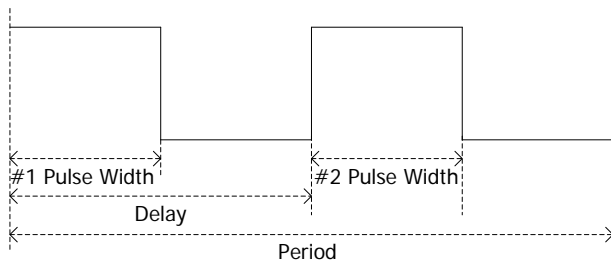

Press **Width** to set the #1 pulse width of the double-pulse modulating signal.

- Use the numeric keyboard or knob to input the desired pulse width value.
- The range of the #1 pulse width is from 10 ns to 170 s – 10 ns.
- The #1 pulse width is limited by the minimum pulse width and delay.
 $\text{Pulse Width} \geq \text{Minimum Pulse Width}$
 $\text{Pulse Width} \leq \text{Delay} - 10 \text{ ns}$

Press **#2 Width** to set the #2 pulse width of the double-pulse modulating signal.

- Use the numeric keyboard or knob to input the desired pulse width value.
- The range of the #2 pulse width is from 10 ns to 170 s – 10 ns.
- The #2 pulse width is limited by the minimum pulse width, pulse period and delay.
 $\#2 \text{ Pulse Width} \geq \#2 \text{ Minimum Pulse Width}$
 $\#2 \text{ Pulse Width} \leq \text{Pulse Period} - \text{Delay} - 10 \text{ ns}$

Press **Delay** to set the delay from the start of the #1 pulse to the start of the #2 pulse of the double-pulse modulating signal.

- Use the numeric keyboard or knob to input the desired delay value.
- The range of the delay is from 20 ns to 170 s – 20ns.

NOTE: When “Ext” modulation source or “Train” pulse mode are selected, the above-mentioned menus are grayed out and disabled.

To Select the Trigger Mode

Press **Pulse** → **Source** to select “Int” modulation source; press **Trig Mode** to select “Auto”, “Ext Trig”, “Ext Gate”, “Key” and “Bus” trigger mode.

- **Auto**
The default mode is auto. The RF signal generator meets the trigger condition at any time and will start the pulse modulation once the **Pulse** function is enabled.
- **External Trigger**
In external trigger, the RF signal generator accepts the external trigger signal input from the **[PULSE IN/OUT]** connector (as shown in the figure below) at the rear panel. The instrument starts a pulse modulation each time a TTL pulse signal with specified polarity is received. To specify the polarity of the TTL pulse, press **Trig Slope** to select “Pos” or “Neg” and the default is “Pos”.

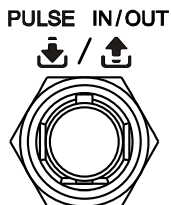

- **External Gate**
In external gate mode, the RF signal generator accepts the external gated signal input from the **[PULSE IN/OUT]** connector at the rear panel. The instrument starts a pulse modulation within the valid level range each time a gated signal with specified polarity is received (as shown in the figure below). To specify the polarity of the gated signal, press **Gate Polar** to select “Normal” or “Inverse” and the default is “Normal”.

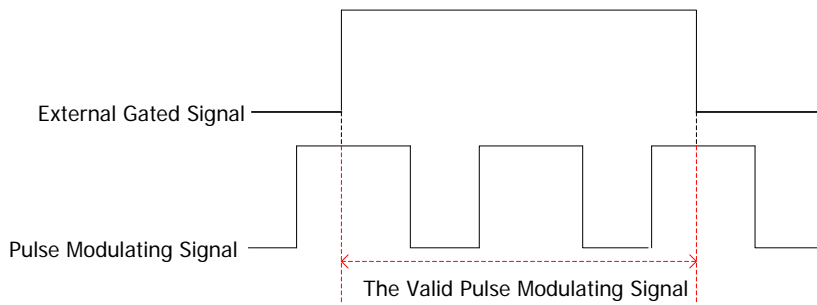

- **Key Trigger**
In key trigger mode, the instrument starts a pulse modulation each time **Trigger** at the front panel is pressed.
- **Bus Trigger**
In bus trigger mode, the instrument starts a pulse modulation each time the “*TRG” command is sent.

NOTE: When “Ext” modulation source is selected, the above-mentioned menus are grayed out and disabled. If “Int” modulation source is selected and “Pulse Out” switch is turned on, **Ext Trig** and **Ext Gate** menus are grayed out and disabled.

Pulse Output

Press **Pulse** → **Source** to select “Int” modulation source; press **Pulse Out** to select “On” or “Off”.

- On: enable the pulse output function. At this point, the RF signal generator can output the pulse signal generated by internal pulse generator from the **[PULSE IN/OUT]** connector at the rear panel. Note, this output signal relates to **Mode** settings.
- Off: disable the pulse output function and this is the default state.

NOTE: When “Ext” modulation source is selected, this menu is grayed out and disabled.

Trigger Delay

Press **Pulse** → **Source** to select “Int” modulation source; after selecting **Ext Trig** mode, press **Trig Delay** set the delay from the start of receiving the external trigger signal to the start of the #1 pulse of the pulse modulating signal. As shown in the following below.

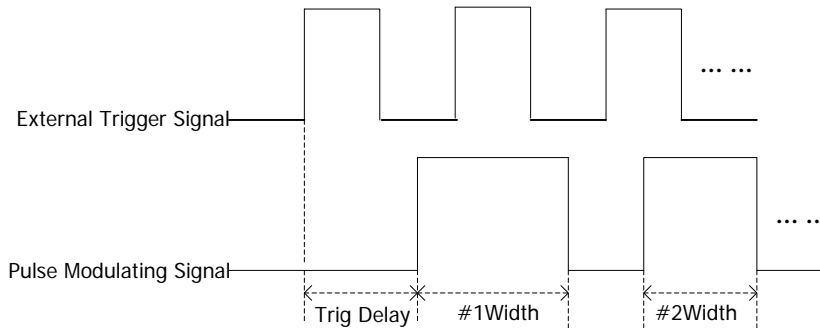

- Use the numeric keyboard or knob to input the desired trigger delay value.
- The range of the trigger delay is from 10 ns to 170 s.

NOTE: When “Ext” modulation source is selected, this menu is grayed out and disabled.

To Set the Polarity

Press **Pulse** → **Polarity** to select “Normal” or “Inverse” to set the polarity of the current pulse modulating signal and the default is “Normal”.

Pulse Train List

Press **Pulse** to use the page up/down key  to open the 3/3 menu page, and then press **Train List** to enter the editing interface of pulse train list. At this point, you can create pulse train list and store the train list finished in internal or external memory. You can also recall the stored train list when required.

SN	Line number, indicates the series number of the pulse to be set. You can add and delete rows using Insert and Delete .
On Time	It indicates the corresponding high level duration of the pulse to be set.
Off Time	It indicates the corresponding low level duration of the pulse to be set.
Repeat	It indicates the repetition times of the pulse to be set.
Dwell Time	It indicates the duration of the pulse to be set currently.

The pulse train edited as shown in the figure below, wherein the repeat number of the first line is two.

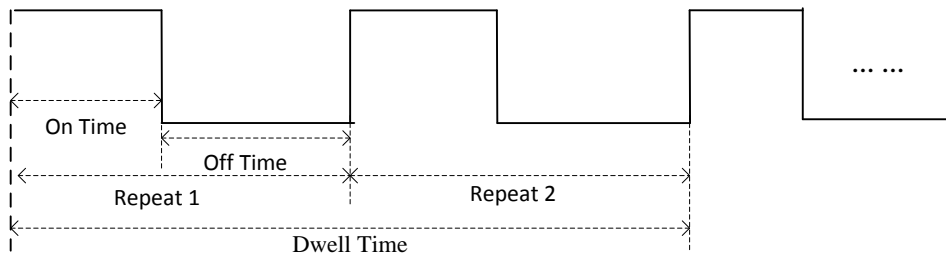

NOTE: When editing pulse train list, you need to install the option PUG-DSG3000. For the specific installation steps, please refer to *DSG3000 Firmware and Options Installation Instruction*.

- **Run**
Press **Run**, you can set the current pulse value to the internal modulating signal. At this point, if “Int” modulation source and “Train” pulse mode are selected and “Pulse Out” switch is turned on, the instrument outputs the corresponding pulse sequence from the **[PULSE IN/OUT]** connector at the rear panel.
- **Insert**
Press **Insert** to insert a row with the same pulse value below the current row. At this point, the number of rows of the pulse train list increases by one.
- **Delete**
Press **Delete** to delete the pulse value of the row currently selected. At this point, the number of rows of the pulse train list reduces by one.
- **Goto Row**
Press **Goto Row** to select the desired row for edit in the pop-up menu. It is usually used to modify the pulse value of the specified row.

N: press **n** and use the numeric keyboard to input the desired row number to select that row. The row number input should not be greater than the total number of rows of the current list.

Top: press **Top** to select the first row of the current list.

Mid: press **Mid** to select the row at the middle of the current list.

Bottom: press **Bottom** to select the last row of the current list.

When the desired row is selected, press  to return to the previous menu to modify the calibration value of the row currently selected.

- Load
Press **Load** to open the store and recall interface. At this point, you can select and read the pulse train list file stored. For detailed operations, refer to the introduction in "**Store and Recall**". You can edit or modify the train list recalled.
- Store
Press **Store** to open the store and recall interface. At this point, you can save the pulse train list file currently edited. For the detailed operations, please refer to the introduction in "**Store and Recall**".

Tips

Edit pulse train list:

Use the direction keys or knob to select the "On Time", "Off Time" and "Repeat" of the pulse to be set in the train list. Press the numeric keyboard to input the value and select the desired unit from the pop-up unit menu or unit keys. You can also press **Enter** to select the default unit s or confirm input.

I/Q Modulation (Option IQ-DSG3000)

I/Q modulation can improve the spectrum utilization. In IQ modulation, two orthogonal carrier signals (with the same frequency and 90° phase difference, generally expressed with Sin and Cos) are modulated with the I (In-Phase component) and Q (Quadrature Phase component) signals respectively and then they are transmitted together.

To Enable I/Q Modulation

Press **I/Q** → **Switch** to select “On” or “Off”.

- On: enable the I/Q modulation function. The backlight of **I/Q** goes on and the I/Q label is displayed in the function status area in the user interface.
- Off: disable the I/Q modulation function and this is the default state.

To Select the Modulation Source

Press **I/Q** → **Source** to select “Int” or “Ext” modulation source.

1. Internal Source

When “Int” is selected, the built-in baseband generator provides the modulating signal. At this point, if the baseband output switch is turned on, the RF signal generator will output the I (In-Phase) components and Q (Quadrature Phase) components of the I/Q modulation from the **[I OUT]** and **[Q OUT]** connectors (as shown in the figure below) on the rear panel.



2. External Source

When “Ext” is selected, the RF signal generator receives the in-phase baseband signal and quadrature phase modulating signal of the I/Q modulation input from the **[I IN]** and **[Q IN]** connectors (as shown in the figure below) on the rear panel. When the baseband output switch is turned on, the instrument can output the I (In-Phase) components and Q (Quadrature Phase) components of the I/Q modulation from the **[I OUT]** and **[Q OUT]** connectors on the rear panel.

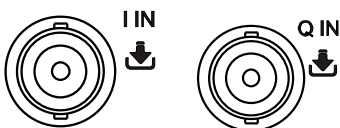

Baseband Signal

1. Baseband Output

Press **I/Q** → **BaseBand** → **Switch** to select “On” or “Off”.

- On: enable the baseband output function. The RF signal generator outputs the I (In-Phase) and Q (Quadrature Phase) components of the I/Q modulation from the **[I OUT]** and **[Q OUT]** connectors on the rear panel.
- Off: disable the baseband output function.

2. Baseband Level

Press **I/Q** → **BaseBand** → **Level** to set the amplitude of the baseband output signal.

- Use the numeric keyboard to input the amplitude value and select the desired unit from the pop-up unit menu or unit keys. You can also press **Enter** to select the default unit (dBm).
- The amplitude units available are V, mV, μ V, nV and dBm.
- You can press the left/right direction keys to enter the parameter editing state. Then, move the cursor to the specified digit and use the up/down direction keys or knob to modify the parameter value.
- You can also use the up/down direction keys or knob to modify the amplitude at the current step.
- Press **Step** to set the step.

3. ARB

Press **I/Q** → **BaseBand** → **ARB** to enter the store and recall interface. At this time, the message “You can load the ARB files” is displayed in the user interface. Press **Enter** or the right direction key to unfold the current directory and select the ARB file (namely wavetable file; the format is *.arb) to be loaded. Then press **Recall** to load this file. The message “File loading succeeded” is displayed after the file is loaded. For more information about how to load a file, please refer to “**Store and Recall**”.

Tips

The loadable ARB files include the default wavetables of the instrument and the wavetables which are downloaded to the DSG3000 using the Ultra IQ Station PC software. For more information about how to download the ARB file, please refer to *Ultra IQ Station_Help Document*.

4. Clock Frequency

Press **I/Q** → **BaseBand** → **Clock Freq** to set the clock rate of the ARB output. You can modify this parameter using the numeric keyboard or knob.

- The units available are GHz, MHz, kHz and Hz.
- Press **Enter** to select the default unit (MHz).
- You can press the left/right direction keys to enter the parameter editing state and move the cursor to the specified digit and use the up/down direction keys or knob to modify the parameter value.
- You can also use the up/down direction keys or knob to modify the clock frequency at the current step.
- Press **Step** to set the step.

NOTE: When loading the ARB file, this value will be automatically set to the clock frequency of the current ARB file.

5. Trigger

(1) Trigger Mode

Select the trigger mode of IQ modulation baseband output.

Press **Trig Mode** to select "Auto", "Key", "Bus" or "Ext".

- **Auto Trigger**
This is the default mode. The RF signal generator fulfills the trigger condition at any time and it will output the IQ baseband signal continuously.
- **Key Trigger**
After selecting the "Key" trigger mode, the instrument will output the baseband signal each time **Trigger** on the front panel is pressed.
- **Bus Trigger**
After selecting the "Bus" trigger mode, the instrument will output the baseband signal each time the *TRG command is sent.
- **External Trigger**
When selecting the "Ext" trigger mode, the RF signal generator receives the trigger signal input from the **[TRIGGER IN]** connector (as shown in the figure below) on the rear panel. The instrument will output the baseband signal each time a TTL pulse signal with the specified polarity is received.



(2) Operation Mode

Select the operation mode after the I/Q modulation baseband signal is triggered.

Press **Opt Mode** to select "Retrig", "Arm Auto", "Arm Retrig" or "Single".

NOTE: When the "Auto" trigger mode is selected, this menu is grayed out and disabled.

- Retrigger
Select the "Retrig" mode. At this point, the instrument outputs the baseband signal continuously and restarts to output the signal each time a trigger is received.
- Arm Auto
After selecting the "Arm Auto" mode, the instrument starts outputting the signal continuously each time a trigger is received until "**Arm ARB**" is selected and then waits for the next trigger.
- Arm Retrigger
After selecting the "Arm Retrig" mode, the instrument starts outputting the signal continuously each time a trigger is received. The instrument restarts outputting the signal when a trigger is received until "**Arm ARB**" is selected and then waits for the next trigger.
- Single
After selecting the "Single" mode, the instrument outputs the specified length (specified in "**Duration**") of waveform each time a trigger is received, and then stops and waits for the next trigger.

(3) Arm ARB

Press **Arm ARB** to manually stop the waveform output and wait for the next trigger.

NOTE: This menu is valid only when the "Arm Auto" or "Arm Retrig" operation mode is selected.

(4) Duration

Press **Duration** to set the duration of the single trigger signal.

NOTE: This menu is only available when selecting the "Single" operation mode. This value defines the number of points (N_r) and the instrument acquires the actual time (T_r) according to the current sample rate (S_a). They satisfy the following relation: $T_r = N_r / S_a$.

(5) External Delay

Press **Ext Delay** to set the trigger delay when the external trigger signal is received.

NOTE: This menu is only available when selecting the “Ext” trigger mode. This value defines the number of points (N_d) and the instrument acquires the actual time (T_d) according to the current sample rate (S_a). They satisfy the following relation: $T_d = N_d / S_a$.

(6) External Inhibit

Press **Ext Inhibit** to set the time from when an external trigger signal is received to when the instrument receives the next trigger signal.

NOTE: This menu is only available when selecting the “Ext” trigger mode. This value defines the number of points (N_i) and the instrument acquires the actual time (T_i) according to the current sample rate (S_a). They satisfy the following relation: $T_i = N_i / S_a$.

LF Output

LF output refers to the output of the low-frequency signal generated by the internal generator of the RF signal source. When analog modulation is enabled, LF outputs the internal modulating signal. If the analog modulation is disabled, LF outputs several common waveforms. You can set the frequency and amplitude of the low-frequency signal.

To Enable the LF Output

Press **LF** to enable the LF output. The backlight of the key goes on and the LF label is displayed in the status bar and the function status area in the user interface. At this point, the **[LF OUTPUT]** connector (as shown in the figure below) outputs the LF signal according to the current configuration.

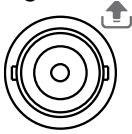

LF OUTPUT

To Set the LF Parameters

Press **LF/AUX** → **LF** to set the “Waveform”, “Level” and “Freq” of the LF output signal.

Explanation

1. When the AM or FM/ ϕ M function and **MOD** switch are enabled, and the internal modulation source is selected, **Waveform** and **Freq** are grayed out and disabled. At this point, the waveform and frequency of the LF output signal should be set via **Waveform** and **Freq** (or **Rate**) under the AM or FM/ ϕ M function and the amplitude of the LF output signal (namely the modulating signal) should be set via **Level**.
2. When all analog modulations which use the internal modulation source are turned on simultaneously and all modulation frequencies and waveforms are consistent, the parameter settings of LF output signal are determined by the last configuration.
3. Turn on the **MOD** switch; any one of the AM or FM/ ϕ M function is enabled and “Ext” modulation source is selected; all menus under the **LF** are grayed out and disabled; you cannot set the frequency and amplitude of the LF output signal. At this point, the actual LF output is consistent with the external modulating signal. When “Int & Ext” modulation source is selected, LF output frequency is half the frequency of internal modulating signal.

To Select the LF Waveform

Press  → **LF** → **Waveform** to set the waveform of the LF output signal to "Sine", "Square", "Triangle", "Ramp" or "Swp-Sine" and the default is "Sine".

To Set the LF Amplitude

Press  → **LF** → **Level** to set the amplitude of the LF signal.

- Use the numeric keyboard to input the amplitude value and select the desired unit from the pop-up unit menu or unit keys. You can also press **Enter** to select the default unit (V).
- The amplitude units available are V, mV, μ V, nV and dBm.
- You can press the left/right direction keys to enter the parameter editing state and move the cursor to the specified digit and use the up/down direction keys or knob to modify the parameter value.
- You can also use the up/down direction keys or knob to modify the amplitude at the current step.
- Press **Step** to set the step.
- The ranges of Sine, Square, Triangle and Ramp waveform amplitude are from 1mV to 3V.

To Set the LF Frequency

Press  → **LF** → **Freq** to set the frequency of the LF signal.

- Use the numeric keyboard to input the frequency value and select the desired unit from the pop-up unit menu or unit keys. You can also press **Enter** to select the default unit (Hz).
- The frequency units available are GHz, MHz, kHz and Hz.
- You can press the left/right direction keys to enter the parameter editing state and move the cursor to the specified digit and use the up/down direction keys or knob to modify the parameter value.
- After setting the frequency, you can use the up/down direction keys or knob to modify the frequency at the current step.
- Press **Step** to set the step.

Explanation

The ranges of sine and sweep-sine frequency are from 100 mHz to 1 MHz.
The range of square waveform frequency is from 100 mHz to 20 kHz.
The ranges of triangle and ramp waveform frequency are from 100 mHz to 100 kHz.

Sweep-Sine Waveform

The sweep-sine waveform refers to sine waveform changes gradually from the start frequency to stop frequency within the specified time, namely frequency sweep.

1. Select the sweep-sine

Press  → **LF** → **Waveform** to select "Swp-Sine". At this point, the RF signal generator output sweep-sine signal from **[LF OUTPUT]** connector at the front panel according to the current setting.

2. Set the sweep-sine parameters

- **Start Frequency**

Press **Start Freq**, use the numeric keyboard to input the value of the start frequency and select the desired unit from the pop-up unit menu or unit keys. You can also press  to select the default unit (Hz).

- **Stop Frequency**

Press **Stop Freq**, use the numeric keyboard to input the value of the stop frequency and select the desired unit from the pop-up unit menu or unit keys. You can also press  to select the default unit (Hz).

NOTE: After the "Start Freq" or "Stop Freq" is modified, the instrument will restart the sweep and output from the "Start Freq" to "Stop Freq".

- **Amplitude**

Press **Level**, use the numeric keyboard to input the value of the amplitude and select the desired unit from the pop-up unit menu or unit keys. You can also press  to select the default unit (V).

- **Sweep Time**

The sweep time refers to the duration of a sweep.

Press **Sweep Time**, use the numeric keyboard to input the time value and select the desired unit from the pop-up unit menu or unit keys. You can also press  to select the default unit (s).

3. Select the sweep mode

Press **Mode** to select "Cont" or "Single" sweep and the default is "Cont".

- Cont: the instrument sweeps continuously according to the current setting when the trigger condition is met.
- Single: the instrument performs a sweep according to the current setting and then stops when the trigger condition is met.

4. Single Sweep

If the current sweep mode is "Cont", press **Single** to switch the sweep mode to "single". The instrument starts a sweep if the trigger condition is currently met. If the current sweep mode is "Single", press **Single** and the instrument starts a sweep if the trigger condition is currently met.

5. Select the sweep shape

The sweep shape refers to the cycle mode of multiple sweeps.

Press **Shape** to select "Ramp" or "Triangle" and the default is "Triangle".

- Ramp: the sweep period always starts from the start frequency to the stop frequency and the sweep sequence is similar to a ramp waveform.
- Triangle: the sweep period always starts from the start frequency to the stop frequency and then returns back to the start frequency. The sweep sequence is similar to a triangle waveform.

6. Select the trigger mode

Select the trigger mode of the whole sweep period.

Press **Trig Mode** to select "Auto", "Key", "Bus" or "Ext" trigger.

- Auto Trigger
The default mode is auto. The RF signal generator meets the trigger condition at any time and will start sweeping according to the current setting once "Swp-Sine" is selected.
- Key Trigger
After selecting "Key" trigger, if the sweep mode is set to "Cont", the instrument starts a sweep each time **Trigger** at the front panel is pressed. If the sweep mode is "Single", press **Single** to meet the single sweep condition. After that the instrument starts a sweep and then stops each time **Trigger** at the front panel is pressed.

- **Bus Trigger**
After selecting “Bus” trigger, if the sweep mode is set to “Cont”, the instrument starts a sweep each time the “*TRG” command is sent. If the sweep mode is “Single”, press **Single** to meet the single sweep condition. After that the instrument starts a sweep and then stops each time the “*TRG” command is sent.
- **External Trigger**
In external trigger, the RF signal generator accepts the trigger signal input from the **[TRIGGER IN]** connector (as shown in the figure below) at the rear panel. If the sweep mode is set to “Cont”, the instrument starts a sweep each time a TTL pulse signal with specified polarity is received. If the sweep mode is “Single”, press **Single** to meet the single sweep condition. After that the instrument starts a sweep and then stops each time a TTL pulse signal with specified polarity is received.

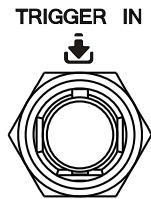

To specify the polarity of the TTL pulse signal, press **Trig Slope** to select “Pos” or “Neg” and the default is “Pos”.

Power Meter (Option PMC-DSG3000)

The DSG3000 can be connected to the USB power sensor or power meter with USB interface via the USB Host interface. In this manual, the Agilent U2004A USB power sensor is taken as an example for description.

After connecting the RF signal source to the AC power supply and turning on it, please refer to *DSG3000 Firmware and Options Installation Instruction* to activate the power meter controller (option PMC-DSG3000). Then, connect the U2004A USB power sensor to the USB Host interface of the DSG3000. If the message “Power meter connected successfully” is displayed in the user interface, you can use the power meter function.

Press **LF/AUX** → **Power Meter** to enter the power meter measurement interface as shown in the figure below.



Figure 2-1 Power Meter Measurement Interface

To Enable the Power Meter

Press **Switch** to select “On” or “Off”.

- On: enable the power meter measurement function. The PWM label is displayed in the function status area in the user interface.
- Off: disable the power meter measurement function and this is the default state.

Zero Type

You can execute the power meter zeroing to reduce the zero measurement deviation and the effect of noise to improve the RF power measurement accuracy.

Press **Zero Type** to select “Int” or “Ext” zero mode.

- **Internal zero**
When selecting this mode, the power sensor can still be connected with the RF signal during the zeroing process. The instrument uses the internal zero by default after powered-on.
- **External zero**
When selecting this mode, you must remove the RF signal to be measured before zeroing the power sensor.

Zero

Press **Zero** and the instrument will perform the power meter zeroing operation according to the “zero type” selected.

Frequency Mode

Select the configuration mode of the measurement frequency.

Press **Freq Mod** to select “Manul” or “Auto” frequency mode.

- **Manul**: in this mode, you can manually set the measurement frequency using **Frequency** softkey.
- **Auto**: the instrument configures this frequency according to the current output frequency of RF signal generator automatically.

Frequency

Press **Frequency** to set the measurement frequency manually.

Tips

When the “Auto” frequency mode is selected, the frequency mode will switch to the “Manul” mode automatically after you set the frequency value via **Frequency**.

Average Measurement

Average Mode

Press **AVG MOD** to select "Manul" or "Auto" average measurement mode.

- Manul: in this mode, you can set the "AVG NUM" of the measurement value manually.
- Auto: the instrument configures the "AVG NUM" according to the measurement value of the current signal automatically.

Average Number

Press **AVG NUM** to set the average number of the signal average measurement manually. The range is from 1 to 1024.

Tips

1. When the "Auto" average mode is selected, the average mode will switch to the "Manual" mode automatically after you set the average number via **AVG NUM**.
2. Increasing the number of averages can reduce the measurement noise, but will increase the measurement time.

Preset

Press **Preset** and the power meter parameters will be restored to the factory default settings.

Limit Measurement

In limit measurement, the measurement is performed within the specified limit range. If the measurement value exceeds this range, the measurement fails.

Measurement Type

Press **Type** to select the limit measurement type, including "Upper", "Lower", "Both" or "Off".

- Upper: select the maximum limit measurement. When the alert function is turned on and the measurement value exceeds the maximum limit, the instrument triggers the alarm.

- Lower: select the minimum limit measurement. When the alert function is turned on and the measurement value exceeds the minimum limit, the instrument triggers the alarm.
- Both: both the maximum limit and the minimum limit measurement are selected at the same time. When the alert function is turned on and the measurement value exceeds any one of the maximum or minimum limit, the instrument triggers the alarm.
- Off: disable the limit measurement function. At this time, the instrument is in unlimited measurement. Even if the alert function is turned on, the instrument will not trigger the alarm.

Maximum Limit

Press **Max Lmt** to set the upper limit of the limit measurement.

Minimum Limit

Press **Min Lmt** to set the lower limit of the limit measurement.

Alert

Press **Alert** to select "On" or "Off".

- On: enable the power meter alert function. At this point, if the measurement value exceeds the limit value (the maximum or minimum limit) and the corresponding limit measurement type is selected, the instrument triggers the alarm.
- Off: disable the power meter alert function.

Tips

1. When the beeper is turned on, the beeper sounds and "Alert" (in red) is displayed in the user interface when the power measurement exceeds the specified range.
2. When the beeper is turned off, only "Alert" (in red) is displayed in the user interface to indicate that the power measurement exceeds the specified range.
3. The detailed alert message is displayed in the message display area of the user interface when the instrument triggers the alarm.

Beeper

Press **Beeper** to select "On" or "Off".

Recorder

In recording file, the measurement data is saved as a record csv file according to the current parameter settings.

Start

Press **Start** to start recording the power meter measurement data. The message "Power meter starts recording" is displayed in the user interface.

Stop

Press **Stop** to stop recording the measurement data. At this point, the message "Power meter stops recording, please save the data" is displayed in the user interface and the instrument enters the store and recall interface. Then, press **Enter** or the right direction key to unfold the current directory and press **Save** to store this file. For more information about storing the file, please refer to "**Save**".

Count

Press **Count** to set the maximum length of the data that can be currently recorded. The range is from 0 to 65535.

Sample Rate

Press **Sample** to set the clock rate of the data points recording.

Data Content

Set the data content to be recorded.

Press **content** to select "All" or "Limit".

- All: record all of the measurement data.
- Limit: only record the limit values of the measurement data.

Relative Measurement

In relative measurement, the instrument computes the measurement result (as a ratio) relative to a reference value.

Switch

Press **Switch** to select "On" or "Off".

- On: enable the relative measurement mode. At this point, the measurement result and the reference value is displayed in dB (the default unit) in the user interface.
- Off: disable the relative measurement mode.

Mode

Select the setting mode of the relative measurement reference value.

Press **Mode** to select "Manul" or "Auto".

- Manul: in this mode, you can set the relative measurement reference value using the **Ref Value** menu manually.
- Auto: the instrument configures the reference value according to the current output level of the RF signal source automatically.

Tips

When the "Auto" mode is selected, the reference value setting mode will switch to "Manul" automatically after you set the reference value via **Ref Value**.

Reference Value

Press **Ref Value** to set the relative measurement reference value.

Statistics

Press **Statistics** to select "On" or "Off".

- On: enable the statistics function of the measurement data. At this point, the "Min", "Avg" and "Max" labels are displayed in the user interface.
- Off: disable the statistics function of the measurement data. At this point, the "Min", "Avg" and "Max" labels in the user interface are grayed out.

Unit

Press **Unit** to set the unit of the measurement value. The available units include dBm and Watts.

NOTE: When the “relative measurement” is turned on, the available units are dB and % and the default unit is dB.

System Information

Press **Information** and the system information of the USB power sensor currently connected is displayed in the text display area of the user interface, including the “Manufacturer”, “Model”, “SN” and “Version”.

RX1000 (Option)

The DSG3000 supports the RX1000 RF Demo Kit provided by **RIGOL**. Press  → **RX1000** to turn on the RX1000 control interface as shown in the figure below.

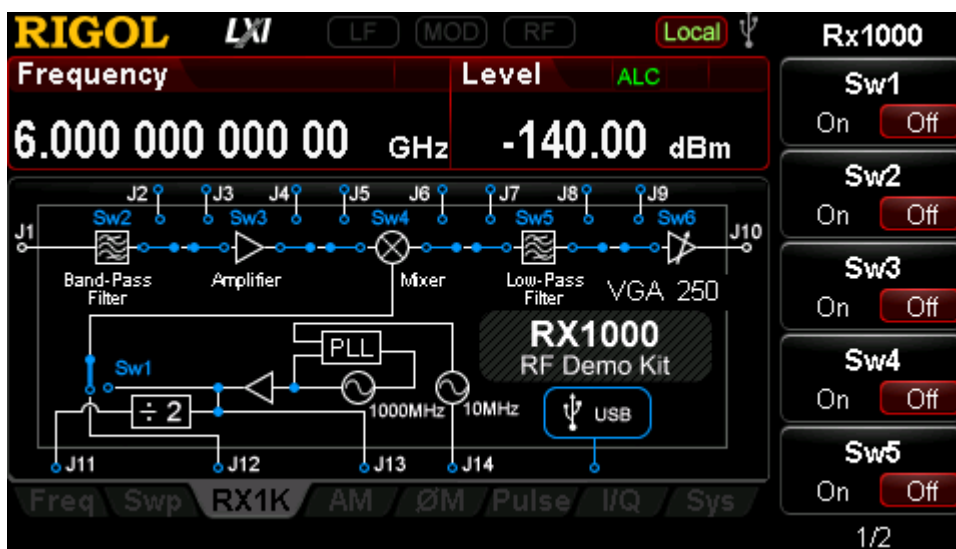

Figure 2-2 RX1000 Control Interface

NOTE: This function is valid only when the RF signal generator is connected with the RX1000 option. For the detailed application of RX1000, please refer to *RX1000_ApplicationNote*.

Store and Recall

DSG3000 allows users to store various types of files to internal or external memory and recall them when required.

DSG3000 provides a local memory (D disk) and an external memory (E disk).

- D disk: provide storage locations for train list, flatness, sweep list and state files.
- E disk: available when USB storage device is detected at the USB Host interface at the rear panel. You can store the files which the same types as the files saved by D disk to USB storage device.

Press **Storage** at the front panel to enter the store and recall interface as shown in Figure 2-3.

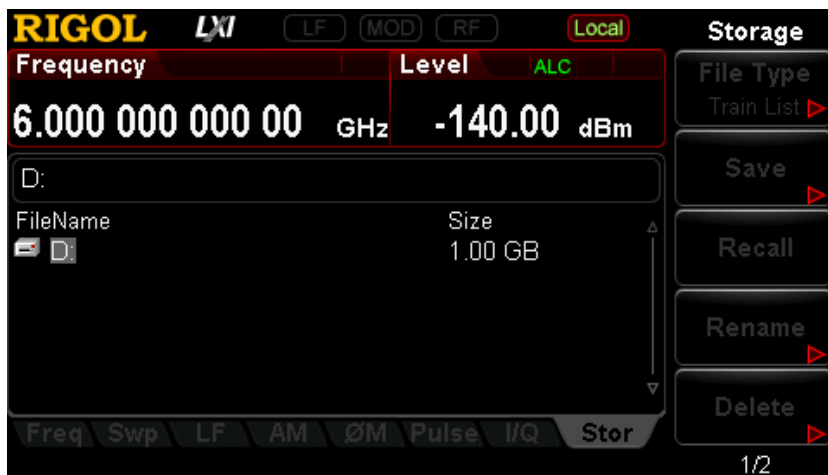

Figure 2-3 store and recall interface

NOTE: DSG3000 can only recognize files with filenames consisting of Chinese characters, English characters and numbers. If other characters are used in the file or folder name, it might not be displayed in the store and recall interface normally.

File Type

In the store and recall interface, use the up/down direction keys or knob to select the current saving directory (when USB storage device detected is available, you can switch between D disk and E disk). Press **File Type** to select the desired file type.

The file types available are all, train list, flatness, sweep list, state, flatness csv, sweep csv, record csv, amplitude calibration, train csv and ARB and the default is "All". The description of each file type is as shown in the table below.

NOTE: If you want to select “Record csv” or “AmpCal” file type, please pre-install the power meter option (PMC-DSG3000), otherwise the menus are grayed out and disabled.

File Type	Format	Suffix	Explanation
Train List	BIN	.TRN	The current train list can be saved by the format of BIN, and you can recall it when required.
Train csv	CSV	.CSV	The current train list can be saved by the format of CSV. You can copy (when saving to D disk) or save it to USB storage device. After that the file can be opened and viewed by a spreadsheet program on the computer.
Flatness	BIN	.FLA	The current flatness list can be saved by the format of BIN and you can recall it when required.
Flat csv	CSV	.CSV	The current flatness list can be saved by the format of CSV. You can copy (when saving to D disk) or save it to USB storage device. After that the file can be opened and viewed by a spreadsheet program on the computer.
Swp List	BIN	.SWP	The current sweep list can be saved by the format of BIN and you can recall it when required.
Swp csv	CSV	.CSV	The current sweep list can be saved by the format of CSV. You can copy (when saving to D disk) or save it to USB storage device. After that the file can be opened and viewed by a spreadsheet program on the computer.
State	BIN	.STA	The current system state can be saved by the format of BIN.
Record csv	CSV	.CSV	The current data recorded by the power meter can be saved by the format of CSV. You can copy (when saving to D disk) or save it to USB storage device. After that the file can be opened and viewed by a spreadsheet program on the computer.
AmpCal	BIN	.ALC	The amplitude difference of sweep list measured by power meter can be saved by the format of BIN.
Arb	BIN	.ARB	The arbitrary waveform file saved by the format of BIN. You can load the file when required.

Tips: You can generate the file of csv format using a spreadsheet program on the computer. Then you can open the file to edit directly the required parameters in the excel table, and save it to USB storage device. In addition, you can also load the file to RF signal generator when required.

Save

1. Select the file type

Please select the desired file type according to the introduction in “File Type”.

NOTE: If **File Type** is set to “All”, the save operation is not available.

2. Open the filename input interface

Press **Enter** or the left/right direction keys to unfold the current directory; press

Save to enter the filename input interface. Press **+/-** **C/E/1** to switch among Chinese, English and number input modes.



Letter Selection Area

Letters Entered

Uppercase/Lowcase

English Input Mode

(a) English Input Mode

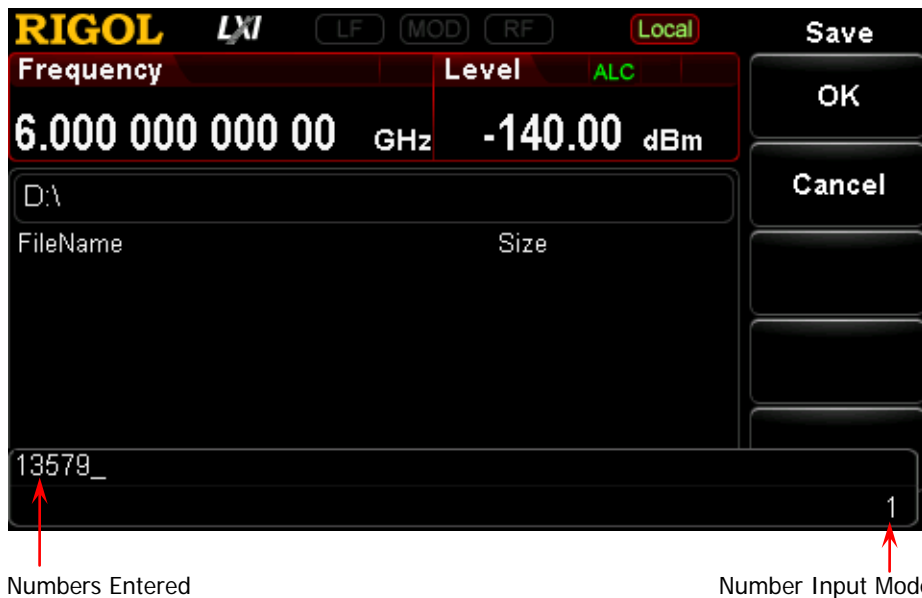

(b) Number Input Mode



(c1) Chinese Input Mode 1

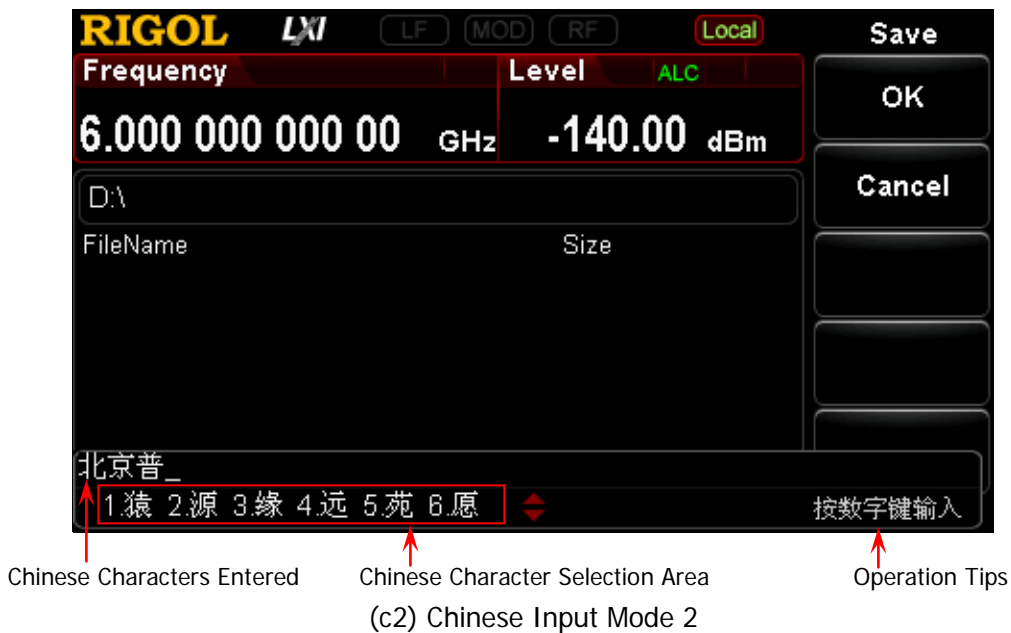

Figure 2-4 Filename Input Interface

3. Input the filename

Input the new filename in the filename input interface. The length of the filename cannot exceed 28 English characters or numbers (or 14 Chinese characters).

● Input English filename

- Press $\left[\begin{smallmatrix} +/- \\ C/E/1 \end{smallmatrix} \right]$ to switch to English input mode. You can use $\left[\begin{smallmatrix} A/B \\ \updownarrow \end{smallmatrix} \right]$ to switch between uppercase and lowercase. At this point, the corresponding label is displayed at the lower-right corner of the filename input interface.
- Press the key of the desired letter. At this point, the letters available are displayed in the **letter selection area**. Press this key continuously or the left/right direction keys or rotate the knob until the background of the desired letter turns red. Then, press $\left[\text{Enter} \right]$ to input the letter.
- Use the above method to input the other letters in the filename.

● Input Chinese filename

- Press $\left[\begin{smallmatrix} +/- \\ C/E/1 \end{smallmatrix} \right]$ to switch to Chinese input mode. At this point, the corresponding label is displayed at the lower-right corner of the filename input interface.
- Press the key of the first letter of the pinyin of the desired Chinese character and the pinyins available are displayed in the **pinyin**

selection area. If the desired pinyin is displayed, refer to step c). If the desired pinyin is not displayed, input the whole pinyin and then refer to c).

- c) Press the left/right direction keys or rotate the knob until the background of the desired pinyin turns red. Press **Enter** to select that pinyin. At this point, the Chinese characters in the **Chinese character selection area** are numbered. Use the numeric keys to select the desired Chinese character. You can use the up/down direction keys or rotate the knob to open the previous page and next page of the **Chinese character selection area**.
- d) Use the same method to input the other Chinese characters.

- **Input number filename**

If you want to use numbers as the filename (or a part of the filename),

press  to switch to number input mode and use the numeric keyboard to input the desired numbers.

4. Save the file

After inputting the filename in the filename input interface, press **OK** and the RF signal generator will save the file with the specified filename in the specified file type under the directory currently selected. Press **Cancel** to cancel the save operation.

- **Replace File:** when the current path has contained a file or folder with the same name, you can press this key to replace the original file or folder.
- **Reenter:** when the current path has contained a file or folder with the same name, you can press this key to back the filename input interface and reenter the filename.

Recall

After selecting a file stored, press **Recall** to read the file selected and load it into the system.

Rename

Modify the filename of the stored file.

After selecting a file stored, press **Rename** to enter the filename input interface, edit a new filename by referring to the introduction in **"Input the filename"** and press **OK** to store the file with the new filename.

Delete

After selecting a file stored, press **Delete** to delete the file selected.

Copy

After selecting a file stored, press **Copy** to select "Copy" or "Paste".

1. Copy

Copy the file or folder selected under the current directory.

2. Paste

Paste the file or folder.

- When the copy path is the same as the paste path and the current path has contained a file or folder with the same name, the corresponding copy file with the "dup" prefix name is generated after performing paste operation.
- When the copy path is different from the paste path and the current path has contained a file or folder with the same name,
 - Replace File: press this key to replace the original file or folder.
 - Cancel: press this key to cancel the paste operation.

To Create a Directory

Create a new folder. The length of the folder name cannot exceed 28 English characters or numbers (or 14 Chinese characters).

In the store and recall interface, use the up/down direction keys or knob to select the current saving directory (when USB storage device detected is available, you can switch between D disk and E disk); press **Enter** or the left/right direction keys to unfold the current directory; press **Create Dir** to enter the filename input interface, edit the folder name according to the introduction in "**Input the filename**" and press **OK** to create an empty folder under the current directory.

Filename Prefix

Press **Storage** → **Name Prefix** to select “Prefix State” or “Edit Prefix”.

1. Prefix State

Press **Prefix State** to select “On” or “Off” to enable or disable the prefix edited. When “On” is selected, the edited prefix will be added into the filename input box automatically when saving file.

2. Edit Prefix

Press **Edit Prefix** to enter the filename input interface and you can use the numeric keyboard to edit the prefix.

Disk Management

Press **Storage** → **Disk Mgr** to select “Format D” or “Disk Info”.

1. Format D

After selecting “D Disk”, press **Format D** → **OK** to format the local disk.

2. Disk Information

Press **Disk Info** to view the disk information including the disk name, type, file system, used space and total space.

System Update

After selecting the update file in the USB storage device, press **Storage** → **Update** to update the software of the RF signal generator.

To Set the System Parameters

Set the system-related parameters.

Language

DSG3000 supports Chinese/English menus, help, interface display and Chinese/English input methods.

Press **System** → **Language** to select the desired language ("English" or "中文").

Reset

Press **System** → **Reset** to perform "Power On", "Preset Type" and "Save Preset" operations.

1. Power On

Press **Power On** to select "Last" or "Preset".

- When "Last" is selected, the system setting before the last power-off will be loaded automatically at power-on.
- When "Preset" is selected, the setting defined in **Preset Type** will be loaded automatically at power-on.

2. Preset Type

Press **Preset Type** to select "Factory" or "User".

- When **Power On** is set to "Preset", the specified preset type will be loaded at power-on.
- After power-on, press **Preset** at the front panel under any operation interface to recall the specified preset type.

3. Save Preset

Press **Save Preset** to store the current system state as user-defined setting in the internal non-volatile memory. When **Preset Type** is set to "User", the current configuration is loaded by recalling "preset".

NOTE: When **Preset Type** is set to "Factory", this menu is grayed out and disabled.

I/O Configuration

The RF signal generator supports LAN, USB and GPIB interface communication.

Press **System** → **I/O Config** to set the “Remote I/O”, “LAN” or “GPIB” parameters.

1. Remote I/O

Press **Remote I/O** to select “LAN”, “USB”, “GPIB”, “Auto” or “Off” and the default is “Off”.

2. LAN

Press **LAN** to set the LAN parameters.

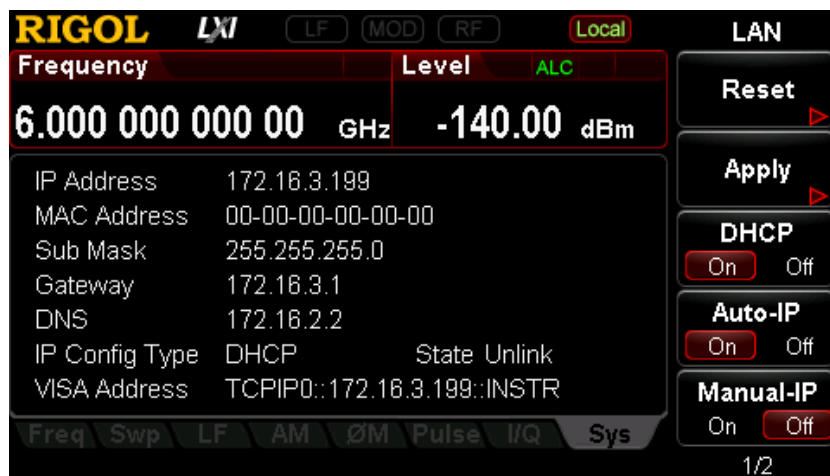

Figure 2-5 To Set the LAN Parameters

- **Reset**
Turn on the DHCP and auto IP and turn off the manual IP. Clear the network password set to restore it to factory setting.
- **Apply**
After configuring LAN parameters, press **Apply** → **OK** to effect the configuration.
- **DHCP**
One of the IP address setting methods. Turn on the DHCP and the DHCP server will assign network parameters (such as the IP address, subnet mask and gateway) for the RF signal generator according to the current network configuration.
- **Auto-IP**
One of the IP address setting methods. Turn on the auto IP and the RF

signal generator will acquire an IP address from 169.254.0.1 to 169.254.255.254 and subnet mask 255.255.0.0 automatically according to the current network configuration.

- **Manual-IP**
One of the IP address setting methods. Turn on the manual IP and users can define the IP address of the RF signal generator.
 - **IP**
Set the IP address, subnet mask and gateway manually.
 - a) Press **IP Address** and use the numeric keyboard to input the desired IP address.
The format of the IP address is nnn.nnn.nnn.nnn. Wherein, the first nnn ranges from 1 to 223 (except 127) and the other three range from 0 to 255. You are recommended to ask your network administrator for an available IP address.
 - b) Press **Sub Mask** and use the numeric keyboard to input the desired subnet mask.
The format of the subnet mask is nnn.nnn.nnn.nnn. Wherein, the range of the nnn is from 0 to 255. You are recommended to ask your network administrator for an available subnet mask.
 - c) Press **Gateway** and use the numeric keyboard to input the desired gateway.
The format of the gateway is nnn.nnn.nnn.nnn. Wherein, the first nnn ranges from 1 to 223 (except 127) and the other three range from 0 to 255. You are recommended to ask your network administrator for an available gateway.
- NOTE:** The RF signal generator always tries to acquire the IP address configuration in the order of DHCP, auto IP and manual IP and the three methods cannot be disabled at the same time.
- **DNS**
Press **DNS** to set the IP address of the DNS server. The format of the DNS address is nnn.nnn.nnn.nnn. Wherein, the first nnn ranges from 1 to 223 (except 127) and the other three range from 0 to 255. You are recommended to ask your network administrator for an available address.

3. GPIB

Set the GPIB address.

Press **GPIB** and you can use the numeric keys, knob or direction keys to modify the parameter. The range is from 0 to 30.

Display Setting

Control the screen display.

Press **System** → **Display** to set the “Scr State” and “Brightness”.

1. Screen State

Press **Scr State** to set the state of the screen.

- On: the default state. Turn on the screen.
- Off: turn off the screen. At this point, the screen stops updating and is locked. Press **Esc** to unlock the screen. Screen locking is used during remote operation mode.

2. Brightness

Press **Brightness** to set the brightness of the LCD backlight of the RF signal generator.

- Use the numeric keys, knob or direction key to modify this parameter.
- The range of the brightness is from 0 to 7.

Power Status

Press **System** → **Power Status** to select “Default” or “Open”.

- Default: after the instrument is powered on and the power switch at the rear panel is turned on, you need to press the power key at the front panel to start the instrument.
- Open: after the instrument is powered on and the power switch at the rear panel is turned on, the instrument starts automatically.

Information

Press **System** → **Information** to view the “System Info”, “HW Info”, “System Msg” or the “Verbose” of system message.

1. System Information

- Model
- Serial NO.
- FW Version
- Boot Version
- Option

2. Hardware Configuration

- RFB Version
- DB Version
- RFB FPGA
- RFB CPLD
- DB FPGA
- DB CPLD

3. System Message

Display the messages recently displayed.

4. Verbose

Press **System Msg** to light the **Verbose** menu. At this point, you can press this softkey to view the complete information of the current row selected in the message list.

License

DSG3000 provides various options to fulfill your measurement requirements. To order the corresponding option, please contact **RIGOL**.

Press **System** → **License** to enter the option management interface to view the option status of the instrument and the license of the option installed. You can also install the option.

1. Option Info

Display the option status of this instrument.

2. License Info

Display the license of the option installed.

3. Install

Input the license key to activate the corresponding option.

Self-test

1. Screen Test

Press **Screen Test** to enter the screen test interface. The system provides five colors (including white, blue, green, red and black) to test whether the display contains bad pixels. Press any key to switch the screen color and exit the test.

2. Key Test

Press **Key Test** to enter the key test interface. Press the function keys at the front panel one by one and check whether the corresponding key is illuminated; if not, failure might occur to that key. Press **Esc** three times to exit the test.

NOTE: If the keys at the front panel are transparent buttons, the corresponding backlight will go on when testing.

Sanitation

Press **System** → **Sanitation** to clear all data set by user and restore them to factory settings.

- Format NAND FLASH;
- The user data saved in the NVRAM and NorFlash are restored to factory settings.
- HOST NAME, IP address and password in LXI are restored to factory settings.

Chapter 3 Remote Control

DSG3000 series RF signal generator can communicate with USB, LAN and GPIB interfaces. This chapter describes the basic information and methods of remote control.

The contents of this chapter are as follows:

- Remote Control Overview
- Control via USB
- Control via LAN
- Control Via GPIB

Remote Control Overview

The DSG3000 supports to build communication with the PC via USB, LAN or GPIB interface to realize remote control. The DSG3000 utilizes a SCPI (Standard Commands for Programmable Instruments) command set (Standard Commands for Programmable Instruments) for remote instrumentation control. There are two modes as follows.

1. User-defined programming



Users can program and control DSG3000 by using the SCPI (Standard Commands for Programmable Instruments) commands. For more information about the commands and programming, refer to the *Programming Guide*.

2. Use PC software

Users can use the PC software to send commands to control DSG3000 remotely. The PC software includes:

- (1) Ultra Sigma (from **RIGOL**),
- (2) Measurement & Automation Explorer (from National Instruments Corporation)
- (3) Agilent IO Libraries Suite (from Agilent Technologies, Inc.)

This chapter will give a detailed introduction of how to use Ultra Sigma to control DSG3000 remotely through various interfaces. Acquire the Ultra Sigma software and install it as well as its components according to the instructions. This software is contained in the resource CD in the standard accessories. You can also download the latest version of the software from www.rigol.com.

NOTE: When the instrument is in remote mode,  is displayed in the user interface and all the front panel keys (except ) are locked. At this point, you can press  to exit the remote mode.

Control Via USB

1. Connect the device

Connect the RF signal generator (USB Device) and PC (USB Host) using USB cable.

2. Install USB drive

This RF signal generator is a USBTMC device and the **New Hardware Wizard** will be displayed after the RF signal generator is correctly connected to the PC (the signal generator will be automatically configured to USB interface) and both of them are started. Please install the “USB Test and Measurement Device” drive program according to the instructions.

3. Search for device resource

Start Ultra Sigma and the software will search for the RF signal generator resource currently connected to the PC automatically. You can also click

USB-TMC

to search for the resource manually.

4. View device resource

The instrument model and USB interface information will be displayed under the “RIGOL Online Resource” directory, as shown in the figure below.

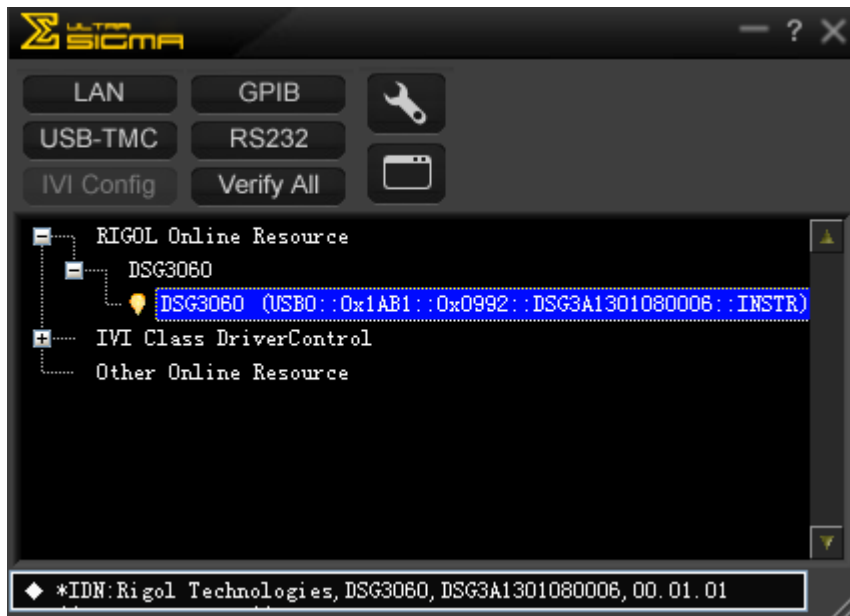

Figure 3-1 View USB Device Resource

5. Communication test

Right-click the resource name "DSG3060 (USB0::0x1AB1::0x0992::DSG3A1301080006::INSTR)" and select "SCPI Panel Control" to open the remote command control panel through which you can send commands and read data. For more information about the SCPI commands, refer to the *Programming Guide*.

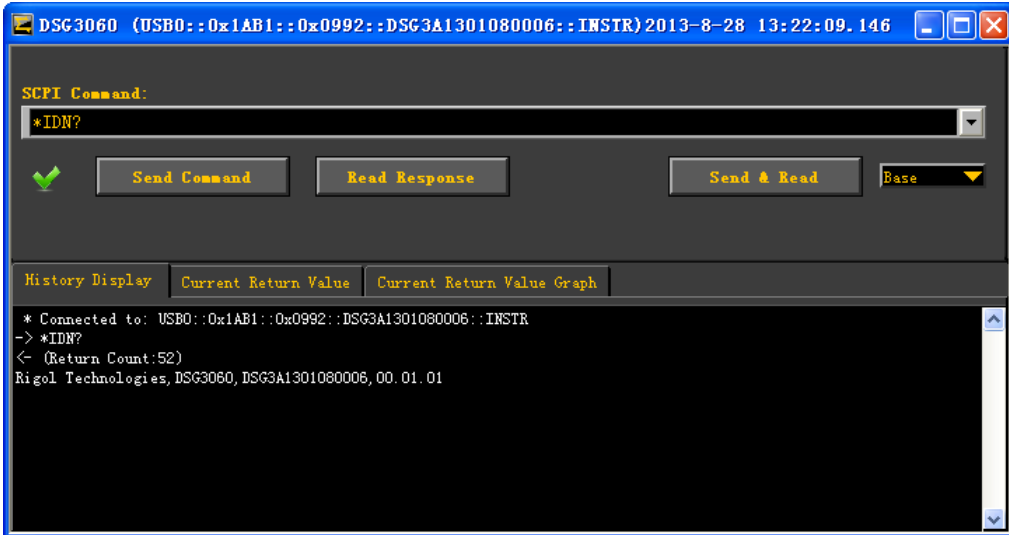

Figure 3-2 Read and Write Command via USB

Control Via LAN

1. Connect the devices

Connect the RF signal generator to your LAN using network cable.

2. Configure LAN parameters

Set the LAN parameters of the RF signal generator according to the description in "I/O Config → LAN".

3. Search device resource

Start-up Ultra Sigma and click **LAN**, then click **Search** in the pop-up window, the software starts searching the RF signal generator resources connected to LAN. Instrument resources searched will be displayed in the right of the window. Select your desired resource and click **OK**, as shown in the following figures.

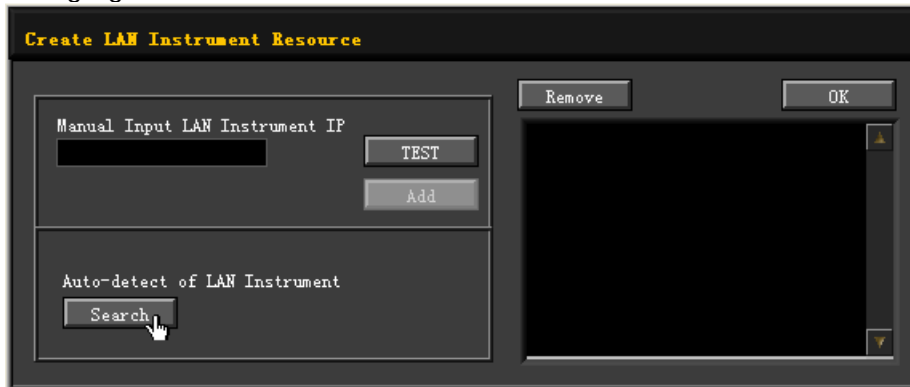

(a)

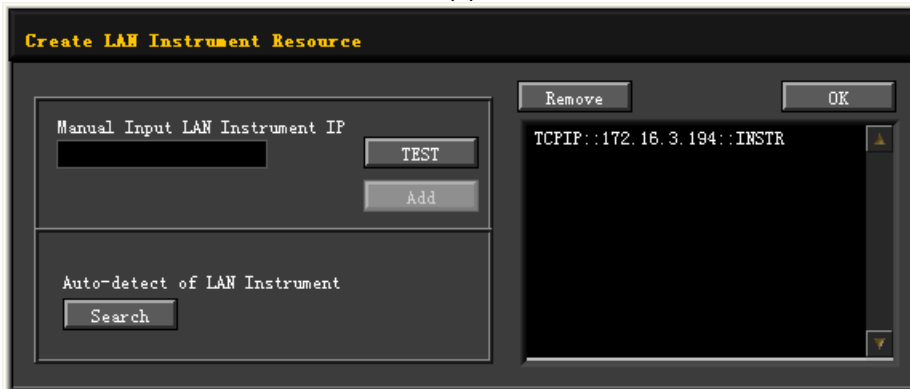

(b)

Figure 3-3 Search LAN resource

NOTE: The resource selected should keep consistency with IP address of the DSG3000 LAN interface.

4. View the resource

The resources that have been searched successfully are shown in the “RIGOL Online Resource” catalog. See figure below.

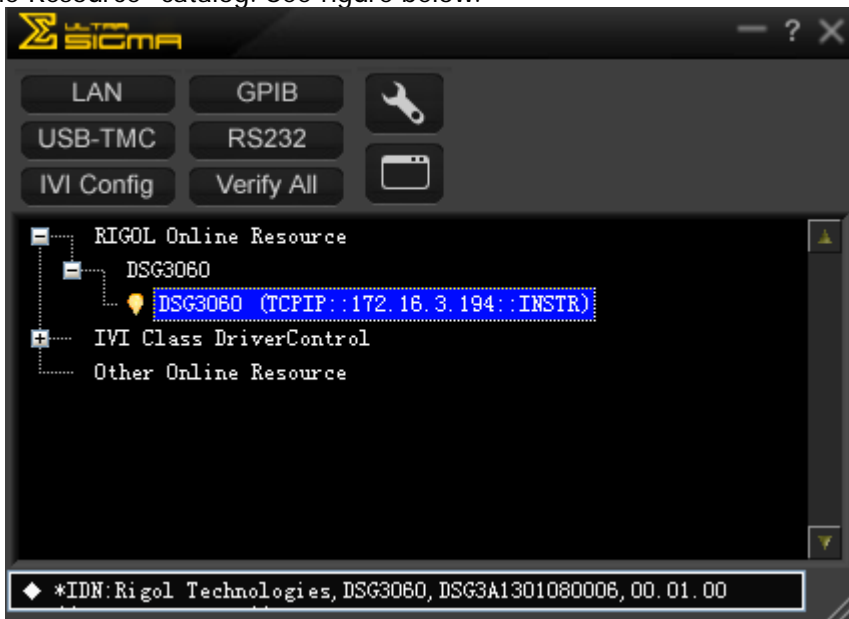

Figure 3-4 View the resource

5. Communication test

Right click the resource name such as **DSG3060 (TCPIP::172.16.3.194::INSTR)** and select **SCPI Panel Control** to open the interface below, from which you can write and read commands as shown in the figure below.



Figure 3-5 Write and read commands via LAN

6. Load LXI webpage

The RF signal generator confirms to LXI core device 2011 class standards. You can load LXI webpage conveniently by right-clicking the resource name and selecting "LXI-Web". From the webpage, you can see some important information about the instrument such as the model, manufacturer, serial number, MAC address, IP address and other descriptions.

Control Via GPIB

1. Connect the devices

Connect the RF signal generator to the PC using GPIB cable.

2. Install the device driver of the GPIB card

Install the driver of the GPIB card which has been connected to the PC.

3. Set the GPIB address

Set the GPIB address following with "I/O Config → GPIB".

4. Search device resource

Start-up the Ultra Sigma and click **GPIB** to enter the following interface. Then, click Search and the software starts searching the RF signal generator resources that that have been connected to PC via GPIB automatically. When a GPIB resource is found, the name of which will be displayed on the right side of the panel.



Figure 3-6 GPIB Setting

If resources cannot be found automatically:

- Select the GPIB card address of the PC and RF signal generator from the combo Box of "GPIB::" and "::INSTR" separately.
- Click "Test" to see if the GPIB communication works normally, if not, please follow the prompt messages step by step.

5. View the resource

Click **OK** and back to the main interface of Ultra Sigma. The resources that have been searched successfully at present are shown in the "RIGOL Online Resource" catalog.

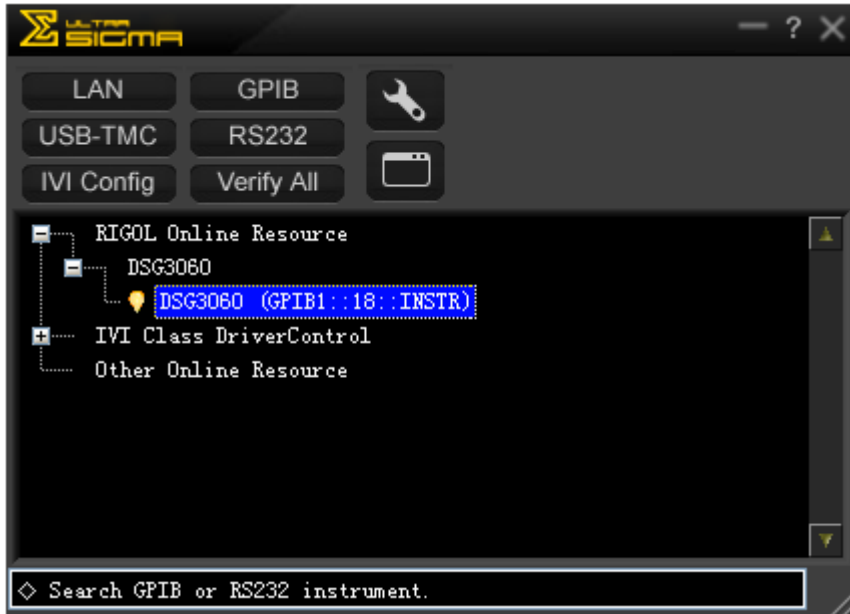

Figure 3-7 View the GPIB resource

6. Communication test

Right-click the resource name such as **DSG3060 (GPIB1::18::INSTR)** and select **SCPI Panel Control** to open the interface below, from which you can write and read commands, see figure below.



Figure 3-8 Write and read commands via GPIB

Chapter 4 Application Examples

This chapter introduces the basic operations of the instrument as well as a few specific examples so that the user can quickly master the use method of the RF signal generator.

The contents of this chapter are as follows:

- To Output RF Signal
- To Output RF Sweep Signal
- To Output RF Modulated Signal
- Pulse Train Application

To Output RF Signal

Output a RF signal with 1 GHz frequency and -40 dBm amplitude from the **[RF OUTPUT 50Ω]** connector.

1. Restore to factory setting

Press **System** → **Reset** → **Preset Type** → “Factory” and then press **Preset** to restore the factory setting (by default, the frequency offset is 0 Hz and the amplitude offset is 0 dB).

2. Frequency setting

Press **FREQ** → **Frequency**, use the numeric keyboard to input the frequency value (1) and select the desired unit (GHz) from the pop-up unit menu or unit keys.

- The frequency units available are GHz, MHz, kHz and Hz.
- Pressing **Enter** can select the default unit Hz.
- You can also press the left/right direction keys to enter the parameter editing state and move the cursor to the specified digit and then use the up/down direction keys or knob to modify the value.
- After the frequency is set, you can use the up/down direction keys or knob to modify the frequency at the current step value.
- Press **FREQ** → **Frequency** and then press **Step** to set the step value.

3. Amplitude setting

Press **LEVEL** → **Level**, use the numeric keyboard to input the amplitude value (-40) and select the desired unit (dBm) from the pop-up unit menu or unit keys. You can also press **Enter** to select the default unit dBm.

- The amplitude units available are dBm, -dBm, mV, uV and nV.
- You can also press the left/right direction keys to enter the parameter editing state and move the cursor to the specified digit and then use the up/down direction keys or knob to modify the value.
- You can also use the up/down direction keys or knob to modify the amplitude at the current step value.
- Press **LEVEL** → **Level** and then press **Step** to set the step value.

4. Enable the RF output

Press **RF**, the backlight goes on and the RF label is displayed in the status bar of the user interface. The RF output is enabled. At this point, the **[RF OUTPUT 50Ω]** connector outputs RF signal according to the current configuration.

To Output RF Sweep Signal

This section introduces how to output a RF sweep signal by configuring continuous linear step sweep. Set the frequency range to 1 GHz ~ 2 GHz, the amplitude range to -20 dBm ~ 0 dBm, the number of sweep points to 10 and the dwell time to 500 ms.

1. Restore to factory setting

Press **System** → **Reset** → **Preset Type** → “Factory” and then press **Preset** to restore the factory setting (by default, the sweep mode is continuous, the sweep type is step and the sweep space is linear).

2. Step sweep parameter setting

Press **SWEEP** and use the menu page up/down key  to turn to the 2/3 menu page; then, press **Step Swp** to enter the step sweep parameter setting interface.

- **Start Frequency**
Press **Start Freq**, use the numeric keyboard to input the start frequency value (1) and select the desired unit (GHz) from the pop-up unit menu or unit keys.
- **Stop Frequency**
Press **Stop Freq**, use the numeric keyboard to input the stop frequency value (2) and select the desired unit (GHz) from the pop-up unit menu or unit keys.
- **Start Level**
Press **Start Lev**, use the numeric keyboard to input the start level value (-20) and select the desired unit (dBm) from the pop-up unit menu or unit keys. You can also press **Enter** to select the default unit (dBm).
- **Stop Level**
Press **Stop Lev**, use the numeric keyboard to input the stop level value (0) and select the desired unit (dBm) from the pop-up unit menu or unit keys. You can also press **Enter** to select the default unit (dBm).
- **Sweep Points**
Press **Points**, use the numeric keyboard to input the number of sweep points (10) and then press **OK** or **Enter**.
- **Dwell Time**
The dwell time indicates the duration of a sweep step.
Press **Dwell Time**, use the numeric keyboard to input the time value (500) and select the desired unit (ms) from the pop-up unit menu or unit keys.

3. Enable the RF sweep

Press **[SWEEP]** → **Sweep** and select “Freq & Level” to enable the frequency and amplitude sweep functions at the same time.

At this point, the RF signal generator sweeps from the start frequency or level to the stop frequency or level continuously at certain step according to the current settings. The frequency and amplitude sweep progress bars as well as the continuous sweep label are displayed in the frequency and amplitude areas in the user interface respectively.

4. Enable the RF output

Press **[RF]**, the backlight goes on and the RF label is displayed in the status bar of the user interface. The RF output is enabled. At this point, the **[RF OUTPUT 50Ω]** connector outputs RF sweep signal according to the current configuration.

To Output RF Modulated Signal

This section introduces how to output an AM modulated signal. Set the carrier frequency to 800 MHz, the carrier amplitude to -20 dBm, the AM modulation depth to 60% and the modulation frequency to 20 kHz.

1. Restore to factory setting

Press **System** → **Reset** → **Preset Type** → "Factory" and then press **Preset** to restore the factory setting (by default, the modulation source is internal and the modulation waveform is sine).

2. Set the carrier frequency and amplitude

(1) Carrier Frequency

Press **FREQ** → **Frequency**, use the numeric keyboard to input the frequency value (800) and select the desired unit (MHz) from the pop-up unit menu or unit keys.

(2) Carrier Amplitude

Press **LEVEL** → **Level**, use the numeric keyboard to input the amplitude value (-20) and select the desired unit (dBm) from the pop-up unit menu or unit keys. You can also press **Enter** to select the default unit (dBm).

3. Set the AM modulation parameters

(1) Press **AM** to enter the amplitude modulation parameter setting interface.

(2) Press **Depth**, use the numeric keyboard to input the value of the modulation depth (60) and select the desired unit (%) from the pop-up unit menu or by pressing **Enter**.

(3) Press **Freq**, use the numeric keyboard to input the frequency value (20) and select the desired unit (kHz) from the pop-up unit menu or unit keys.

(4) Press **Switch** and select "On" to enable the AM function. The backlight of **AM** goes on.

4. Enable the RF modulation output

Press **MOD** and the backlight goes on. Then, press **RF** and the backlight goes on. The MOD and RF labels are displayed in the status bar of the user interface. The RF modulation output is enabled. At his point, the **[RF OUTPUT 50Ω]** connector outputs RF modulated signal according to the current configuration.

NOTE: The backlights of **RF** and **MOD** should be lit.

Pulse Train Application

Output a user-defined pulse train from **[PULSE IN/OUT]** connector. The specific parameters to be set in the pulse list as shown in the table below.

SN	On Time	Off Time	Repeat
1	10ms	30ms	2
2	20ms	40ms	1

1. Restore to factory setting

Press **System** → **Reset** → **Preset Type** → "Factory" and then press **Preset** to restore the factory setting.

2. Install Pulse Train Generator (Option)

Please refer to *DSG3000 Firmware and Options Installation Instruction* to install and activate the pulse train generator (option PUG-DSG3000).

3. Edit the Pulse Train List

Press **Pulse** to use the page up/down key  to open the 3/3 menu page, and then press **Train List** to enter the editing interface of pulse train list.

- **Insert**
If the parameter values in the current list are the only one row, press **Insert** to insert a row with the same pulse value below the current row.
- **Delete**
If the parameter values in the current list are more than two lines, you can press **Delete** to delete the pulse value of the row currently selected, and last retain the only two rows parameters.
- **Edit**
Use the direction keys or knob to move the cursor and select the parameters of the first row to be edited.
 - On Time: use the numeric keyboard to input the value 10, and select the desired unit (ms) from the pop-up unit menu or unit keys.
 - Off Time: use the numeric keyboard to input the value 30, and select the desired unit (ms) from the pop-up unit menu or unit keys.
 - Repeat: use the numeric keyboard to input the value 2, and then press **Enter** softkey or **Enter**.
 - Use the same method to set the pulse parameters of the second row.

NOTE: Dwell time is calculated automatically by the three parameters (On Time, Off Time and Repeat) to be set.

- Run
Press **Run**, you can set the current pulse value to the internal modulating signal.
4. **Select the Pulse Mode**
Press **Pulse** → **Source** to select “Int” modulation source; press **Mode** to select “Train”.
 5. **Enable the Pulse Output**
Press **Pulse Out**, and select “On” to enable the pulse output function. At this point, the RF signal generator can output the pulse signal generated by internal pulse train generator from the **[PULSE IN/OUT]** connector at the rear panel.

Chapter 5 Troubleshooting

The chapter lists the commonly encountered failures and their solutions. When you encounter those problems, please solve them following the corresponding steps. If the problem remains still, please contact **RIGOL** and provide your device information (**System** → **Information** → **System Info**).

1. The screen of the RF signal generator is still dark (no display) after pressing the power key:

- (1) Check whether the fan is running;
 - If the fan is running but the screen is dark, the screen connecting wire might be loose.
 - If the fan is not running and the instrument does not start successfully, please go to step (2).
- (2) Check whether the power is correctly connected and the power switch is really on.
- (3) Check whether the fuse is burned out. If the fuse needs to be replaced, please use the specified fuse (AC 250V, T2A).
- (4) Restart the instrument after finishing the above inspections.
- (5) If it still does not work correctly, please contact **RIGOL**.

2. The screen is too dark and cannot be seen clearly:

- (1) Check whether the brightness setting of the LCD screen is too low.
- (2) Press **System** → **Display** → **Brightness** and use the numeric keys or up/down direction keys to adjust the brightness of the LCD screen of the RF signal generator to a proper value.

3. The RF signal generator is locked:

- (1) Check whether the RF signal generator is in remote control mode (in remote control, **Rmt** is displayed in the status bar of the user interface). Pressing **Esc** can exit the remote control mode and unlock the front panel.
- (2) Check whether the RF signal generator is in local mode with the screen being locked (when the screen is locked, front panel operations are not available). Pressing **Esc** can unlock the screen and exit the locking state.
- (3) If progress bar is displayed on the screen of the signal generator, some operation is in progress. For example, when saving a file, the progress bar will be displayed indicating that the save operation is in progress. At this point, the front panel is locked.
- (4) Pressing **Preset** or restarting the signal generator can also unlock the instrument.

4. The setting is correct but the waveform output is incorrect:

- (1) There is no RF output
 - Check whether the signal connecting cable is tightly connected to the corresponding **[RF OUTPUT 50Ω]** connector.
 - Check whether the connecting cable has internal damage.
 - Check whether the connecting cable is tightly connected to the test instrument.
 - Check whether the backlight of **[RF]** goes on. If not, press this key to illuminate the backlight. At this point, the RF label is displayed in the status bar of the user interface and the RF output is enabled.
 - Check whether the output amplitude of the RF signal is too small. Adjust the output amplitude properly.
- (2) The RF output is not modulated
 - Check whether the signal connecting cable is tightly connected to the corresponding **[RF OUTPUT 50Ω]** connector.
 - Check whether the connecting cable has internal damage.
 - Check whether the connecting cable is tightly connected to the test instrument.
 - Check whether the backlights of **[MOD]** and **[RF]** are both illuminated and check whether the modulation **Switch** is set to “On”.
 - Check whether the modulation parameter setting is correct and adjust the parameter appropriately.
 - If external modulation source is used, make sure that the external source is correctly connected and outputs signal. At the same time, the external source should work within the specified range of the signal generator.

5. The sweep is abnormal:

- (1) The seep stagnates

The sweep progress bar is displayed in the frequency area/amplitude area in the user interface indicating that the sweep is in progress. If the sweep stagnates, please check:

 - At least one manner of sweep is enabled. Press **[SWEEP]** → **Sweep** to select “Freq”, “Level” or “Freq & Level”.
 - If single sweep mode is selected, press **Single** and the instrument performs a sweep if the trigger condition is met.
 - If the sweep trigger mode is not set to auto, press **[SWEEP]** → **Trig** → “Auto” to make sure whether the sweep stagnates due to the loss of sweep trigger.
 - If the point trigger mode is not set to auto, press **[SWEEP]** → **Point Trig** → “Auto” to make sure whether the sweep stagnates due to the loss of point trigger.
 - Make sure whether the dwell time is too large or too small that the sweep cannot be seen.
 - Make sure that at least two points are set in the step sweep or list sweep.

- (2) The dwell time of list sweep is incorrect
 - Press **SWEEP** → **List Swp** to enter the sweep list editing interface.
 - Make sure whether the dwell time of the list sweep is correct.
 - If the dwell time is incorrect, re-edit it. If it is correct, turn to the next step.
 - Press **SWEEP** → **Sweep Type** to make sure that “List” sweep is selected.
If “Step” sweep is currently selected, the signal generator sweeps according to the dwell time of the step sweep.
- (3) The list sweep information recalled from the register is lost
 - The list sweep information cannot be stored in the status register of the instrument as a part of the instrument state.
 - The signal generator can only use the current list for sweep and you can store the list sweep data to the local directory of the instrument.
- (4) In list or step sweep, the amplitude does not change
 - Make sure that the sweep manner is set to “Level” or “Freq&Level”.
 - If the sweep manner is currently set to “Freq”, the amplitude will not change.

6. The USB storage device cannot be recognized:

- (1) Check whether the USB storage device can work normally when connected to other instrument or PC.
- (2) Make sure that the USB storage device used is a Flash type. This instrument does not support hardware USB storage device.
- (3) Restart the instrument and insert the USB storage again to check whether it can work normally.
- (4) If the USB storage device still cannot be used normally, please contact **RIGOL**.

7. No response or incorrect response when key is pressed:

- (1) After starting the instrument, make sure that whether all the keys are irresponsive.
- (2) Press **System** → **Self-test** → **Key Test** to enter the keyboard test interface. Press the function keys at the front panel sequentially and check whether some key gives no response or incorrect response when it is pressed.
- (3) If the above failures occur, the keyboard connecting wire might be loose or the keyboard is damaged. Please do not disassemble the instrument and contact **RIGOL**.

8. Performance specification test is not passed:

- (1) Check whether the RF signal generator is within calibration period (1 year).
- (2) Make sure that the RF signal generator is warmed up for at least 30 minutes before test.
- (3) Check whether the RF signal generator is under the specified temperature.

- (4) Check whether the test is being performed in a highly magnetic environment.
- (5) Check whether the power supplies of RF signal generator and test system have strong interference.
- (6) Check whether the performance of the test device meets the requirement.
- (7) Make sure that the test device is within calibration period.
- (8) Check whether the test device meets the required conditions of the manual.
- (9) Check whether all connections are tight.
- (10) Check whether all cables have internal damage.
- (11) Make sure that the operations conform to settings and processes which are required by the performance verification manual.
- (12) Check whether the error calculation is a mistake.
- (13) The definitions of "Typical Value" and "Nominal Value" for this product should be correctly understood.
 - Typical Value: the performance specification of this product under specified conditions.
 - Nominal Value: the approximate quantity of the product during application.

Chapter 6 Specifications

This chapter describes the specifications of RF signal generator. Specifications are valid under the following conditions: the instrument in the calibration cycle is stored at least two hours at 0°C to 50°C temperature, and 40 minutes warm up. The specifications include measurement uncertainty. Data represented in this manual are specifications unless otherwise noted.

Typical (typ.): describes characteristic performance, which 80 percent of the measurement results will meet at room temperature (approximately 25 °C). This data is not warranted, does not include measurement uncertainty.

Nominal (nom.): indicates the expected mean or average performance, or an attribute whose performance is by design, such as the 50 ohm connector. This data is not warranted and is measured at room temperature (approximately 25 °C).

Measured (meas.): describes an attribute measured during the design phase for purposes of communicating expected performance, such as amplitude drift vs. time. This data is not warranted and is measured at room temperature (approximately 25 °C).

NOTE: All values represented in this chapter are the measurement results of multiple instruments at room temperature unless otherwise noted.

Specifications

Frequency

Frequency		
Frequency range	DSG3030	9kHz to 3GHz
	DSG3060	9kHz to 6GHz
Frequency resolution	0.01Hz	
Frequency switching speed	<10ms ^[1] (typ.)	
Phase offset	Adjustable in 0.01° steps (nom.)	

Frequency Bands ^[2]		
Band	Frequency	N
1	$f \leq 23.4375\text{MHz}$	1
2	$23.4375\text{MHz} < f \leq 46.875\text{MHz}$	0.03125
3	$46.875\text{MHz} < f \leq 93.75\text{MHz}$	0.0625
4	$93.75\text{MHz} < f \leq 187.5\text{MHz}$	0.125
5	$187.5\text{MHz} < f \leq 375\text{MHz}$	0.25
6	$375\text{MHz} < f \leq 750\text{MHz}$	0.5
7	$750\text{MHz} < f \leq 1500\text{MHz}$	1
8	$1500\text{MHz} < f \leq 3000\text{MHz}$	2
9	$3000\text{MHz} < f \leq 6000\text{MHz}$	4

Internal Reference Frequency		
Reference frequency	10MHz	
Temperature stability	In temperature range 0°C to 50°C, reference to 25°C	< 0.5ppm
	With OCXO-A08 option	< 5ppb
Aging rate		< 1ppm/year
	With OCXO-A08 option	< 30ppb/year
Output for internal reference frequency	Frequency	10MHz
	Level	+8dBm (typ.)
	Output impedance	50Ω (nom.)
Input for external reference frequency	Frequency	10MHz
	Level	0dBm to +10dBm
	Maximum deviation	±5ppm
	Input impedance	50Ω (nom.)

NOTE: [1] Except in the case when band1 is switched with another band.

[2] N is a factor used to help define certain specifications within the document.

Frequency Sweep		
Operating modes	Step sweep (equally or logarithmically spaced frequency steps) List sweep (the list of arbitrary frequency steps)	
Sweep modes	Single, continuous	
Sweep range	Full frequency range	
Sweep shapes	Triangle, ramp	
Step change	Linear or logarithmic	
Number of points	Step sweep	2 to 65535
	List sweep	1 to 6001
Dwell time range	20ms to 100s	
Triggering	Auto, trigger key, external, bus (GPIO, USB, LAN)	

Spectral Purity ^[1]		
Harmonics	CW mode, $1\text{MHz} \leq f \leq 6\text{GHz}$, level $\leq +13\text{dBm}$	<-30dBc
Sub harmonics	CW mode	
	$f \leq 3\text{GHz}$	<-65dBc, <-80dBc (typ.)
	$3\text{GHz} < f \leq 6\text{GHz}$	<-52dBc, <-70dBc (typ.)
Non harmonics	CW mode, level > -10dBm, carrier offset > 10kHz	
	$f \leq 1.5\text{GHz}$	<-64dBc, <-70dBc (typ.)
	$1.5\text{GHz} < f \leq 3\text{GHz}$	<-58dBc, <-64dBc (typ.)
	$3\text{GHz} < f \leq 6\text{GHz}$	<-52dBc, <-58dBc (typ.)
SSB phase noise	CW mode, at 20kHz carrier offset, 1Hz measurement bandwidth	
	$f = 100\text{MHz}$	<-120dBc/Hz
	$f = 1\text{GHz}$	<-108dBc/Hz, <-110dBc/Hz (typ.)
	$f = 3\text{GHz}$	<-102dBc/Hz, <-104dBc/Hz (typ.)
	$f = 6\text{GHz}$	<-96dBc/Hz, <-98dBc/Hz (typ.)
Residual FM	RMS value at $f = 1\text{GHz}$, CW	
	0.3kHz to 3kHz	<5Hz rms, <1Hz rms (typ.)
	0.03kHz to 20kHz	<30Hz rms, <8Hz rms (typ.)

NOTE:[1] Without IQ-DSG3000 option.

Level

Setting Range			
		Specification level range	Setting range
Maximum output level	$9\text{kHz} \leq f < 100\text{kHz}$	+7dBm	+10dBm
	$100\text{kHz} \leq f < 1\text{MHz}$	+13dBm	+15dBm
	$1\text{MHz} \leq f \leq 3\text{GHz}$	+13dBm	+25dBm
	$3\text{GHz} < f \leq 6\text{GHz}$	+13dBm	+20dBm
Minimum output level	$9\text{kHz} \leq f < 100\text{kHz}$	-110dBm	-120dBm
	$100\text{kHz} \leq f \leq 6\text{GHz}$	-130dBm	-140dBm
Setting resolution	0.01dB		

Absolute Level Uncertainty ^[1]				
Level uncertainty		+13 to -60dBm	-60 to -110dBm	-110 to -130dBm
	$9\text{kHz} \leq f < 100\text{kHz}$	$\leq 0.5\text{dB (typ.)}$	$\leq 0.7\text{dB (typ.)}$	
	$100\text{kHz} \leq f \leq 3\text{GHz}$	$\leq 0.7\text{dB,}$ $\leq 0.5\text{ (typ.)}$	$\leq 0.9\text{dB,}$ $\leq 0.5\text{ (typ.)}$	$\leq 0.7\text{dB (typ.)}$
	$3\text{GHz} < f \leq 6\text{GHz}$	$\leq 0.9\text{dB,}$ $\leq 0.5\text{ (typ.)}$	$\leq 1.1\text{dB,}$ $\leq 0.5\text{ (typ.)}$	$\leq 0.9\text{dB (typ.)}$
VSWR ^[2]	$1\text{MHz} \leq f \leq 6\text{GHz}$	$< 1.8\text{ (typ.)}$		

Level Setting		
Setting time	ALC state on, frequency fixed, temperature range: 20°C to 30°C	$\leq 5\text{ms (typ.)}$
Uninterrupted level setting range	ATT fixed mode, ALC state on, level range -110dBm to +13dBm	$> 20\text{dB (typ.)}$

Max. Reverse Power		
Max. reverse power	Max. DC voltage	50V
	$1\text{MHz} < f \leq 6\text{GHz}$	10W

NOTE: [1] ALC state: on or auto mode, 20°C to 30°C

[2] In 50Ω system, typical, level $\leq -10\text{dBm}$, ATT auto mode

Level Sweep		
Operating modes	Step sweep (equally spaced level steps) List sweep (the list of arbitrary level steps)	
Sweep modes	Single, continuous	
Sweep range	Full level range	
Sweep shape	Triangle, ramp	
Step change	Linear	
Number of points	Step sweep	2 to 65535
	List sweep	1 to 6001
Dwell time range	20ms to 100s	
Triggering	Auto, trigger key, external, bus (GPIB, USB, LAN)	

Internal Modulation Generator (LF)

Internal Modulation Generator (LF)		
Waveforms	Sine, square, triangle, ramp, sine sweep	
Frequency range	Sine, sine sweep	0.1Hz to 1MHz
	Square	0.1Hz to 20kHz
	Triangle, ramp	0.1Hz to 100kHz
Resolution	0.01Hz	
Frequency error	Same as RF reference source	
Output voltage ^[1]	Setting range	1mV to 3V
	Resolution	1mV
Output impedance	50Ω (nom.)	
Sine sweep	Sweep modes	Single, continuous
	Sweep range	Frequency range of LF output
	Sweep time	1ms to 1000s
	Sweep shapes	Triangle, ramp
	Triggering	Auto, trigger key, external, bus (GPIB, USB, LAN)

NOTE: [1] Measurement in high-impedance state.

Modulation ^[1]

Simultaneous Modulation					
	AM	FM	ØM	Pulse mod.	I/Q mod. (opt.)
AM	—	○	○	△	×
FM	○	—	×	○	○
ØM	○	×	—	○	○
Pulse mod.	△	○	○	—	○
I/Q mod.(opt.)	×	○	○	○	—

NOTE: ○:compatible; ×: incompatible; △:compatible with AM Performance reduced

Amplitude Modulation		
Operating modes	Internal, external, internal + external	
Modulation depth ^[2]	The modulation depth that can be set from +7dBm to +13dBm observing the AM specifications continuously decrease.	0% to 100%
Resolution	0.1%	
AM depth uncertainty	$f_{\text{mod}}=1\text{kHz}$	<4% of setting+1%
AM distortion	$f_{\text{mod}}=1\text{kHz}$, $m<30\%$, level=0dBm	<3% (typ.)
Modulation frequency response	$m<80\%$, 10Hz to 50kHz	<3dB (nom.)

Frequency Modulation		
Operating modes	Internal, external, internal + external	
Maximum deviation	$N \times 1\text{MHz}$ (nom.)	
Resolution	<0.1% of deviation, or 1Hz, whichever is greater (nom.)	
Setting uncertainty	$f_{\text{mod}}=1\text{kHz}$, internal mode	<2% of setting+20Hz
FM distortion	$f_{\text{mod}}=1\text{kHz}$, deviation= $N \times 50\text{kHz}$	<2% (typ.)
Modulation frequency response ^[3]	10Hz to 100kHz	<3dB (nom.)

NOTE: [1] The modulation source is sine waveform unless otherwise noted.

[2] Peak power of the envelope is no more than the maximum value of the specification output range.

[3] External operating mode, measured at 100 kHz deviation.

Phase Modulation		
Operating modes	Internal, external, internal + external	
Maximum deviation	$f \leq 23.4375\text{MHz}$	3rad(nom.)
	$f > 23.4375\text{MHz}$	$N \times 5\text{rad}$ (nom.)
Resolution	<0.1% of deviation, or 0.01rad, whichever is greater, (nom.)	
Deviation accuracy	$f_{\text{mod}}=1\text{kHz}$, internal modulation source	<1% of setting+0.1rad
ØM total harmonic distortion	$f_{\text{mod}}=1\text{kHz}$, deviation=5rad	<1% (typ.)
Modulation frequency response ^[1]	10Hz to 100kHz	<3dB (nom.)

Pulse Modulation		
Modulation source	External, internal	
On/off ratio	$25\text{MHz} \leq f < 3\text{GHz}$	>80dB
	$3\text{GHz} \leq f \leq 6\text{GHz}$	>70dB
Rise/fall time (10%/90%)	<50ns ^[1] , 10ns (typ.)	
Pulse repetition frequency	DC to 1MHz	

Pulse Generator		
Operating modes	Single pulse, double pulse, pulse train(option PUG-DSG3000)	
Pulse period	Setting range	40ns to 170s
	Resolution	10ns
Pulse width	Setting range	10ns to (170s-10ns)
	Resolution	10ns
Trigger delay	Setting range	10ns to 170s
	Resolution	10ns
Double-pulse spacing	Setting range	20ns to (170s-20ns)
	Resolution	10ns
Triggering	Auto, external trigger, external gate, trigger key, bus (GPIB, USB, LAN)	

Pulse Train Generator (Option PUG-DSG3000)		
Pulse train generator	Number of pulse patterns	1 ~ 2047
	On/off time range	20ns to 170s
	Repetition per pattern	1 to 256

NOTE: [1] External operating mode, measured at 5rad deviation.

[2]The state of ALC is off.

I/Q Modulation (Option IQ-DSG3000)		
Modulation source	External, internal	
Bandwidth (RF)	External modulation	
	Baseband (I or Q)	≤ 120MHz (nom.)
	RF (I + Q)	≤ 240MHz (nom.)
	Internal modulation	
	Baseband (I or Q)	≤ 30MHz (nom.)
	RF (I + Q)	≤ 60MHz (nom.)
Carrier suppression ^[1]	Carrier frequency range: 50MHz ≤ f ≤ 6GHz	≥ 40dBc (typ.)
Suppression of image sideband ^[2]	Modulation bandwidth up to ±10MHz	≥ 40dBc (typ.)
External I/Q inputs	VSWR	< 1.5
	Full scale input	$\sqrt{I^2 + Q^2} = 0.5V_{rms}$
Internal modulation		
EVM	16QAM , root cosine filter (α=0.22), 4MSps	
	50MHz ≤ f ≤ 3GHz (level≤4dBm)	≤ 0.7%rms (typ.)
	3GHz < f ≤ 6GHz (level≤0dBm)	≤ 1.2%rms (typ.)
	QPSK , root cosine filter (α=0.22), 4MSps	
	50MHz ≤ f ≤ 3GHz (level≤4dBm)	≤ 0.7%rms (typ.)
	3GHz < f ≤ 6GHz (level≤0dBm)	≤ 1.2%rms (typ.)
External modulation		
EVM	CDMA2000/1xEV-DO, 1.2288 Mcps, frequency 800 to 900MHz, 1800 to 1900MHz, level≤4dBm	≤ 1.2%, ≤ 0.8% (typ.)
ACPR		≥ 70dB

NOTE: [1] [2]The parameter is measured at room temperature. When the temperature is difference from room temperature, the specification will deteriorate.

I/Q Baseband Generator (Option IQ-DSG3000)			
Output impedance	50Ω (nom.)		
Output voltage	Setting range	0.1V _{DD} to 1.5V _{DD}	
	Resolution	1mV	
Frequency response	Referenced to 1MHz	≤ 10MHz	<0.5dB (nom.)
		≤ 30MHz	<1dB (nom.)
I/Q imbalance	Magnitude	≤ 10MHz	<0.1dB (nom.)
		≤ 30MHz	<0.2dB (nom.)
	Nonlinear phase	≤ 10MHz	200ps (nom.)
		≤ 30MHz	500ps (nom.)
SFDR	Sine	≤ 30MHz	>50dB (nom.)
Waveform memory	Waveform length	1 sample to 8 Msample in one-sample steps	
	Resolution	14 bits	
	Loading time 1Msample	<10 s ^[1] (nom.)	
	Nonvolatile memory	1G Bytes	
Sample rate	Setting range	1 kHz to 50 MHz, 100 MHz	
	Resolution	0.01 Hz	
Trigger	Triggering	Auto, trigger key, external, bus (GPIB, USB, LAN)	
	Operating modes	Retrig, armed auto, armed retrigger, single	
	External trigger delay		
	Setting range	0 to (2 ¹⁶ – 1)	
	Resolution	1	
	External trigger inhibit		
	Setting range	0 to (2 ¹⁶ – 1)	
	Resolution	1	
External trigger pulse width	>20 ns (nom.)		

NOTE: [1] Load from flash internal non-volatile memory.

Inputs and Outputs

Front Panel Connectors		
RF output	Impedance	50Ω (nom.)
	Connector	N female
External modulation signal input	Impedance	50Ω (nom.)
	Connector	BNC female
Internal modulation generator (LF) output	Impedance	50Ω (nom.)
	Connector	BNC female

Rear Panel Connectors		
External trigger in	Impedance	1kΩ (nom.)
	Connector	BNC female
	Trigger voltage	5V TTL level
Signal valid output	Connector	BNC female
	Output voltage	0V/3.3V (nom.)
Sweep out	Connector	BNC female
	Output voltage	0 to 10V (nom.)
Pulse input or output	Impedance	50Ω (nom.)
	Input/output voltage	0V/3.3V (nom.)
10MHz in (external frequency reference input)	Impedance	50Ω (nom.)
	Connector	BNC female
10MHz out (external frequency reference output)	Impedance	50Ω (nom.)
	Connector	BNC female
I/Q baseband input/output (option IQ-DSG3000)	Impedance	50Ω (nom.)
	Connector	BNC female

Rear Panel Communication Interface		
USB host	Connector	A plug
	Protocol	Version2.0
USB device	Connector	B plug
	Protocol	Version2.0
LAN	LXI core device 2011 class	10/100Base,RJ-45
IEC/IEEE bus (GPIB)		IEEE488.2

General Specifications

Display	
Type	TFT LCD
Resolution	480*272
Size	4.3"

Mass Memory		
Mass memory	Flash non-volatile memory (internal); USB disk (not supplied)	
Data storage space	Flash non-volatile memory (internal)	1G Bytes

Power Supply		
Input voltage range, AC	100V to 240V (nom.)	
AC supply frequency	45Hz to 440Hz	
Power consumption	With all options	50W (typ.), max. 60W

Electromagnetic Compatibility and Safety		
EMC	In line with EN61326-1:2006	
	IEC 61000-4-2:2001	$\pm 4.0\text{kV}$ (contact discharge), $\pm 4.0\text{kV}$ (air discharge)
	IEC 61000-4-3:2002	3V/m (80MHz to 1GHz) 3V/m (1.4GHz to 2GHz) 1V/m (2.0GHz to 2.7GHz)
	IEC 61000-4-4:2004	1kV power lines
	IEC 61000-4-5:2001	0.5kV (phase to Neutral) 0.5kV (phase to PE) 1kV (neutral to PE)
	IEC 61000-4-6:2003	3V, 0.15-80MHz
	IEC 61000-4-11:2004	Voltage dip: 0% UT during half cycle 0% UT during 1 cycle 70% UT during 25 cycles Short interruption: 0% UT during 250 cycles
Electrical safety	In line with UL 61010-1:2012 CAN/CSA-C22.2 No. 61010-1-12 EN 61010-1:2010	

Environmental		
Temperature	Operating temperature range	0°C to 50°C
	Storage temperature range	-20°C to 70°C
Humidity	0°C to 30°C	≤95% rel. humidity
	30°C to 40°C	≤75% rel. humidity
Altitude	Operating height	Up to 3,048m (10000ft)

Dimensions	
(W × H × D)	364 mm × 112 mm × 420 mm (14.33 in × 4.41 in × 16.54 in)

Weight	
	6.4kg (14.1lb)
With IQ-DSG3000 option	6.7kg (14.8lb)

Chapter 7 Appendix

Appendix A: DSG3000 Accessories and options

	Description	Order Number
Model	Signal Generator, 9kHz to 3GHz	DSG3030
	Signal Generator, 9kHz to 6GHz	DSG3060
Standard accessories	Quick Guide (Hard Copy)	-
	CDROM (User Guide, Programming Guide)	-
	Power Cable	-
Options	Pulse Train Generator	PUG-DSG3000
	High Stable OCXO Reference Clock	OCXO-A08
	I/Q Modulation, Baseband Output	IQ-DSG3000
	Power Meter Controller	PMC-DSG3000
	Rack Mount Kit	RM-DSG3000

NOTE: All instruments, accessories and options can be ordered from your local RIGOL distributors.

Appendix B: Warranty

RIGOL warrants that its products mainframe and accessories will be free from defects in materials and workmanship within the warranty period.

If a product is proven to be defective within the respective period, **RIGOL** guarantees the free replacement or repair of products which are approved defective. To get repair service, please contact with your nearest **RIGOL** sales and service office.

RIGOL does not provide any other warranty items except the one being provided by this summary and the warranty statement. The warranty items include but not being subjected to the hint guarantee items related to tradable characteristic and any particular purpose. **RIGOL** will not take any responsibility in cases regarding to indirect, particular and ensuing damage.

Index

#1 Pulse Width.....	2-28	Level.....	2-35
#2 Pulse Width.....	2-28	LF Amplitude	2-40
ALC	2-7	LF Frequency	2-40
Amplitude	2-4, 2-41	LF Output.....	2-39
Amplitude Calibration	2-52	LF Waveform	2-40
Amplitude Modulation.....	2-19	Limit	2-4
Amplitude Offset.....	2-5	limit measurement.....	2-46
Amplitude Sweep.....	2-10	List Sweep.....	2-11
Arm ARB.....	2-37	Modulation Depth.....	2-20
Arm Auto	2-37	Modulation Frequency.....	2-21
Arm Retrigger.....	2-37	modulation source.....	2-34
Attenuation	2-6	Modulation Waveform	2-20
Attenuation Mode	2-6	OCXO	1-13
Auto Trigger	2-16, 2-17, 2-36, 2-42	Off Time.....	2-31
average measurement.....	2-46	On Time.....	2-31
average number	2-46	operation mode.....	2-37
baseband output.....	2-35	Phase Deviation	2-25
Bus Trigger	2-16, 2-18, 2-30, 2-36, 2-43	Phase Modulation.....	2-24
clock frequency	2-36	Phase Offset	2-3
Continuous Sweep	2-15	Point Trigger Mode.....	2-17
Delay.....	2-29	power meter	2-44
DNS	2-62	Preset List	2-12
Duration	2-37	Pulse Mode.....	2-27
Dwell Time.....	2-14	Pulse Modulation.....	2-26
Ext Delay	2-38	Pulse Output.....	2-30
Ext Inhibit.....	2-38	Pulse Period.....	2-27
External Gate	2-29	Pulse Width	2-27
External Trigger	2-17, 2-18, 2-29, 2-36, 2-43	recording.....	2-48
Flatness Calibration.....	2-7	reference value	2-49
Frequency.....	2-2	relative measurement	2-49
Frequency Deviation	2-23	Repeat	2-31
frequency mode.....	2-45	Reset Sweep.....	2-16
Frequency Modulation	2-22	Retrigger	2-37
Frequency Offset	2-2	RX1000	2-51
Frequency Sweep	2-10	Single.....	2-37
Gateway	2-62	Single Sweep	2-15, 2-42
I/Q modulation.....	2-34	Start Frequency.....	2-13, 2-41
IP Address	2-62	Start Level.....	2-13
Key Trigger.....	2-16, 2-17, 2-30, 2-36, 2-42	Step Sweep	2-13
LAN.....	2-61	Stop Frequency.....	2-13, 2-41
		Stop Level	2-13
		Subnet Mask.....	2-62
		Sweep.....	2-10

Sweep Mode	2-42	Train List	2-31
Sweep Points	2-14	Trigger Delay	2-31
Sweep Shape	2-14	trigger mode	2-36
Sweep Space	2-14	Trigger Mode	2-16, 2-29, 2-42
Sweep Time	2-41	zero	2-45
Sweep-Sine	2-41		